

MAGNUM

# MAGNUM

TRACTORS FROM  
355-404 hp



CASE IH

CASE IH

# MORE POWER. GREATER EFFICIENCY.

Maximum productivity from day one

up to  
**423** hp

# APM

for more efficiency

New hydraulics rear  
**remotes**

Brake to clutch on  
**21x5**  
transmission

# MAGNUM

5 models from 355 to 404 hp

Magnum, the trusted tractor of choice for more than 38 years, steps into its next era of power and efficiency with the latest flagship models. Delivered with advanced, next-gen architecture for best customer experience, these models come with premium upgrades including bundled integrated technology, higher horsepower and easier-to-use hydraulic couplers, allowing the machine to function as the hub of the operation.

## IMPROVED PERFORMANCE

Magnum tractors deliver up to 423 hp and offer two advanced transmission options: the PowerDrive full powershift on the 355 and 405 models, and the CVXDrive on the 355 and 385 models. With up to 358 l/min of hydraulic flow, Magnum tractors are built for serious performance and productivity.

## INTEGRATED TECH EFFICIENCY

Magnum models come fully equipped with integrated, easy-to-use technology that streamlines your operation from day one. With "Connectivity Included", you're connected instantly – no setup needed and no additional costs. Access real-time data, monitor machine performance, and make agronomic decisions through FieldOps™, the intuitive platform for all Case IH precision technology. Efficiency is made simple.

## ENHANCED ACCURACY

Equipped from the factory with the AccuGuide™ automated steering system and ISOBUS Class II or III, Magnum tractors simplify precision farming for every operator. AccuTurn™ Pro takes automation further by combining automatic steering with headland turning functions, enabling fully automated, hands-free turns that boost accuracy, reduce operator fatigue, and maximise productivity.

## POWER TO THE GROUND

Featuring a unique rear track design that blends the advantages of both wheeled and tracked tractors, this system delivers better traction and reduces soil compaction thanks to increased ground contact area. With advanced brake-assisted steering, the Magnum achieves a turning radius up to 20% smaller than the standard 6.8 meters, delivering outstanding manoeuvrability.



**CASE IH**  
FieldOps



SCAN FOR MORE  
INFORMATION!

## MAGNUM 355, 385, 405

- Up to 423 hp maximum power
- 2 transmissions for all kind of applications: the 21F/5R PowerDrive full powershift on Magnum 355 and 405, and the Case IH's continuously-variable CVXDrive transmission on 355 & 385 models
- Top speed of 40 kph ECO and 50 kph ECO
- Up to 358 l/min max. hydraulic pump flow
- More driving comfort due to brake to clutch only on PowerDrive, APM (Automatic Productivity Management) on both
- AccuGuide automated steering system, ISOBUS class II or III and connectivity from factory
- AccuTurn Pro combines automatic steering and headland turning functions for complete automation
- Connectivity included

## MAGNUM 385, 405 ROWTRAC

- Magnum Rowtrac: Unique rear track design combining the benefits of wheeled and tracked versions
- Better traction and less soil compaction due to more contact area between tractor and field
- Brake-assisted steering: The turning radius of 6.8 meters can be reduced by up to 20%, ensuring exceptional manoeuvrability
- AccuTurn Pro combines automatic steering and headland turning functions for complete automation



PREMIUM  
SOUNDSYSTEM

ZONE CONTROLLED  
HVAC AIRFLOW

DUAL CASE IH PRO 1200  
DISPLAY AND LCD WITH  
ANTI-GLARE SCREENS  
(OPTIONAL)

MOBILE PHONE  
HOLDER

INSTRUMENT  
CLUSTER WITH  
KEY MACHINE  
INFORMATION

REDESIGNED,  
ERGONOMIC,  
MULTIFUNCTION  
HANDLE

ENCODER  
KNOB

INTEGRATED  
COOL BOX  
(OPTIONAL)

LUXURY LEATHER,  
HEATED / VENTILATED SEAT  
WITH 40-DEGREE SWIVEL

MOTORCYCLE-STYLE  
FOOT PEGS

LUXURY LEATHER  
INSTRUCTOR SEAT

STORAGE, USB,  
PIN/12-VOLT POWER  
AND DATA PORTS  
THROUGHOUT THE CAB

# YOUR FAVOURITE WORK PLACE

## The most comfortable cab

### A HOMEY WORKSPACE

Climb up the wide, lit steps with handrails and get into the bright, quiet cab featuring a noise level of just 67 dB(A) and 6.3 m<sup>2</sup> of windows. Automatic climate control, which you can adjust on the Case IH Pro 1200 monitor, combined with an active suspension driver's seat makes this our most comfortable suspended cab yet.

### COMFORT MEETS FUNCTIONALITY

The new 4-pillar design with 360° views and the newly redesigned Multicontroller armrest make long working days easier. The driver's seat swivels 40°, letting you check on your implements without twisting your neck. It feels like a suspended rear axle – the optional semi-active hydraulic cab suspension absorbs shocks and vibrations, delivering a smoother, more stable ride.

### AN EYE FOR DETAIL

The new Magnum cab has incorporated a lot of new ideas. There's ample, well-organized storage, and an optional large integrated cool box on the right-hand side. A drawer under the instructor seat provides space for bulky items. The electrical features have also been upgraded. All the common electrical connections are located exactly where needed - overhead, behind the

Multicontroller armrest, and on both fenders. Other features such as a Bluetooth radio, powered mirrors, climate control, up to four windscreen wipers and up to four sun shades round out the extensive interior.

### NEW ACCESS CONTROL

The updated key system adds convenience and protection to your daily work. The key fob allows you to lock and unlock the cab remotely and prevents unauthorized operation – the tractor starts only with a recognized key. More comfort, more security, and full control right in your hand.

### ADVANTAGES

- Up to 20 powerful LED work lights
- Colour performance monitor mounted on the right A-pillar
- Front, rear and right side sunshades
- Electrically adjustable telescoping mirrors
- Automatic climate control
- Motorcycle-style foot pegs
- Mobile phone holder and wireless charger
- Integrated cool box



THE SEMI-ACTIVE, HYDRAULIC CAB SUSPENSION RELIABLY ABSORBS JOLTING AND VIBRATIONS.



THE REMOVABLE COOL BOX KEEPS DRINKS AND SNACKS CLOSE AT HAND – EASY TO TAKE OUT, REFILL, AND READY FOR LONG DAYS IN THE FIELD.



THE SWIVEL SEAT TURNS UP TO 40° – GIVING A CLEAR VIEW OF REAR IMPLEMENTS AND GREATER COMFORT DURING LONG WORKING HOURS.

# BUILT BIG FOR LONG DAYS IN THE FIELD

While others squeeze you in – we give you room to breathe, move, and get more done



# BREAKING THE LIMITS OF CUSTOMISATION

Everything under control

The Pro 1200 monitor maximises control and automation in the cab. With just a few touches, operators can view and fine-tune most machine functions. Each driver can configure and save submenu and shortcut options to suit their needs.

## THE PRO 1200 MONITOR

- 12" size
- Anti-fingerprint coating
- Bluetooth® pairing with mobile phone
- Ambient light sensor
- Multi-touch screen
- USB port
- Stand-by mode
- 4 cameras can be connected to the Pro 1200 monitor

## MULTICONTROLLER ARMREST

- Multicontroller
- PTO controls
- Ergonomical remote valve controls
- Configurable buttons (AUX-N)
- Three-point linkage
- Headland management
- Auto diff-lock
- Automatic Productivity Management
- Exclusive encoder knob



# CUSTOMISE YOUR EXPERIENCE

Choose from over 100 functions to assign to eight freely-programmable key buttons.



## PERSONALISE YOUR WORKING SCREEN

Operators can create up to seven personalised run screens and decide which machine data or functions appear on each – ensuring that the most relevant information is always visible.



## CONFIGURE AUXILIARY BUTTONS

Assign implement functions according to individual preferences or implement requirements thanks to AUX-N capability.



## ADJUSTABLE FOR YOUR PERFECT VIEW

The monitor pivots through 52 degrees so you can have it just where you want it.



## EXCLUSIVE ENCODER KNOB

The integrated encoder allows an easy navigation and an accurate monitor set-up under harsh field condition.



# SIMPLY HIGH PERFORMANCE

Perfectly balanced components

The Magnum's FPT Cursor 9 engine with modern Common Rail four valve technology, intercooler and turbocharger with variable geometry (eVGT) is one of the most innovative and environmentally-compatible engines in the industry.

## MASSIVE POWER FROM THE 8.7 L ENGINE

Case IH FPT engines achieve up to 10% power growth, providing the power you need when you need it. They also feature a power boost of up to 35 additional horsepower to maintain speed and productivity when on the road or using PTO applications. The system constantly monitors the operating conditions of the transmission, PTO and hydraulics, reacting to greater demand with additional power.

## ENOUGH RESERVES WHEN NEEDED

Thanks to an impressive torque rise of up to 40%, the engine has enough torque reserves to manage even the toughest pulling or PTO work even with falling rpms. This phenomenal pulling power results from the engine's ability to generate maximum torque over a large power range.



The next generation Cursor 9 delivers an expanded horsepower range, from the new Magnum 355 up to the 405 – providing the power and endurance needed for heavy-draft applications such as tillage and seeding. We've enhanced the rated horsepower curves to deliver a significant boost in productivity for heavy-draft applications.



## APM SYSTEM (AUTOMATIC PRODUCTIVITY MANAGEMENT)

Set your desired ground speed and let APM do the work – the system automatically maintains a constant speed throughout field operations, optimising performance and saving up to 20% in fuel consumption.

## ADVANTAGES

- Up to 10% power growth to maximise performance in the toughest conditions
- 600-hour oil change interval reduces your maintenance costs

# THE PROVEN FULL POWERSHIFT TRANSMISSION

Efficient power transfer increases productivity

Magnum tractors are built for productivity and ease, helping you meet farming demands. With the proven PowerDrive transmission and APM, you get efficient power delivery and reduced fuel consumption.

The rugged and proven 21-speed PowerDrive transmission is engineered for heavy-duty performance and maximum efficiency. Featuring Automatic Productivity Management (APM) diesel saver mode, it automatically maintains a consistent set speed under varying load conditions, optimising fuel use without sacrificing power. With smooth shifting that reduces operator fatigue, PowerDrive delivers reliable power transfer designed to keep your operation productive and the operator comfortable all day long.

## ADDITIONAL FEATURES

- **Smooth power delivery** – Shift seamlessly through all 21 forward and 5 reverse gears with no torque interruption, ensuring consistent performance and comfort.
- **Efficient road transport** – Achieve up to 53 km/h at just 1,815 rpm, reducing fuel consumption and operator fatigue during transport.
- **Optimised for heavy work** – Eight working speeds between 4 and 12 km/h provide ideal gear spacing for field operations and maximum pulling power.
- **Intelligent control and comfort** – Automatic Productivity Management (APM) adjusts engine speed and gear ratio for the best balance of performance and fuel economy.

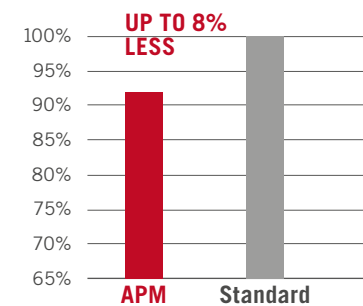

Auto Road: reduced fuel consumption by using this mode



# CVXDRIVE - THE CONTINUOUSLY VARIABLE DRIVE

Our drive gets you going

## A NEW DRIVING EXPERIENCE WITH CUSTOMISABLE TRANSMISSION SETTINGS

Case IH software engineers have enhanced the performance and driveability of the CVXDrive with new APM control features that deliver smoother and more responsive characteristics, increasing uptime in the field. Drivers can choose between three pre-defined settings or customise the settings according to their needs, easily and quickly via the Pro 1200 display.

## ADVANTAGES

- Best-in-class driving comfort thanks to the CVXDrive continuously variable transmission
- Perfectly smooth acceleration and deceleration for greater operator comfort
- Precise and responsive shuttle behaviour for faster direction changes
- Refined drive pedal sensitivity for optimal control in every situation
- Cruise control override for effortless speed adjustments
- Instant response to pedal kick-down for maximum performance on demand

COMPOUND PLANET GEAR-SET THAT COMBINES ENGINE AND A HYDRO-MOTOR SPEED

4 MECHANICAL RANGES ENSURE EXCELLENT EFFICIENCY

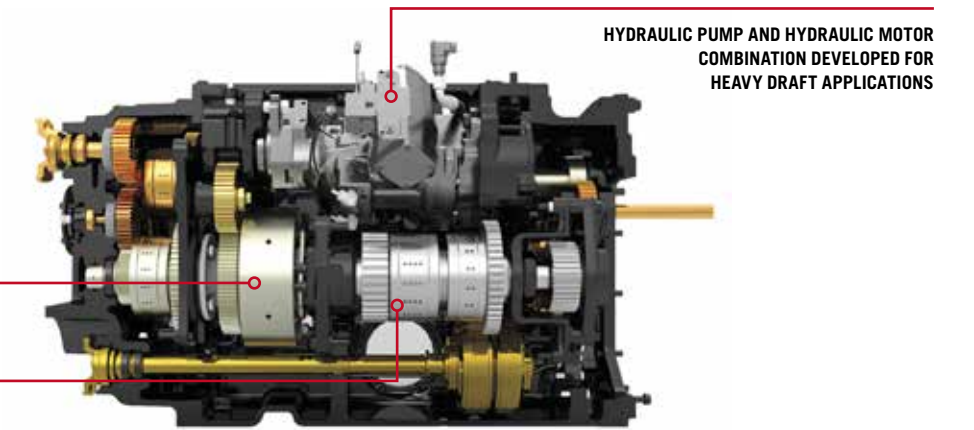

HYDRAULIC PUMP AND HYDRAULIC MOTOR COMBINATION DEVELOPED FOR HEAVY DRAFT APPLICATIONS

# STRENGTH THAT KEEPS YOU STEADY

## ADVANTAGES

- Front axle suspension for a smooth ride and increased traction
- 4WD and differential lock management
- Versatile tyre range up to 2.18 m diameter
- Up to 1,225 kg front ballast or 2x1,250 kg rear wheel ballast
- Adaptive Steering Control (ASC) is standard
- Optional tyre pressure monitoring of tractor and trailers on the Pro 1200 monitor

THE CASE IH MAGNUM ENGINE IS MOUNTED IN A HEAVY CAST CONTOURED CHASSIS, REDUCING VIBRATION THROUGHOUT THE MACHINE AS THE ENGINE IS NOT A STRUCTURAL TRACTOR COMPONENT – ALLOWING HIGHER PAYLOAD CAPACITY, IMPROVED DURABILITY, AND GREATER OVERALL STABILITY

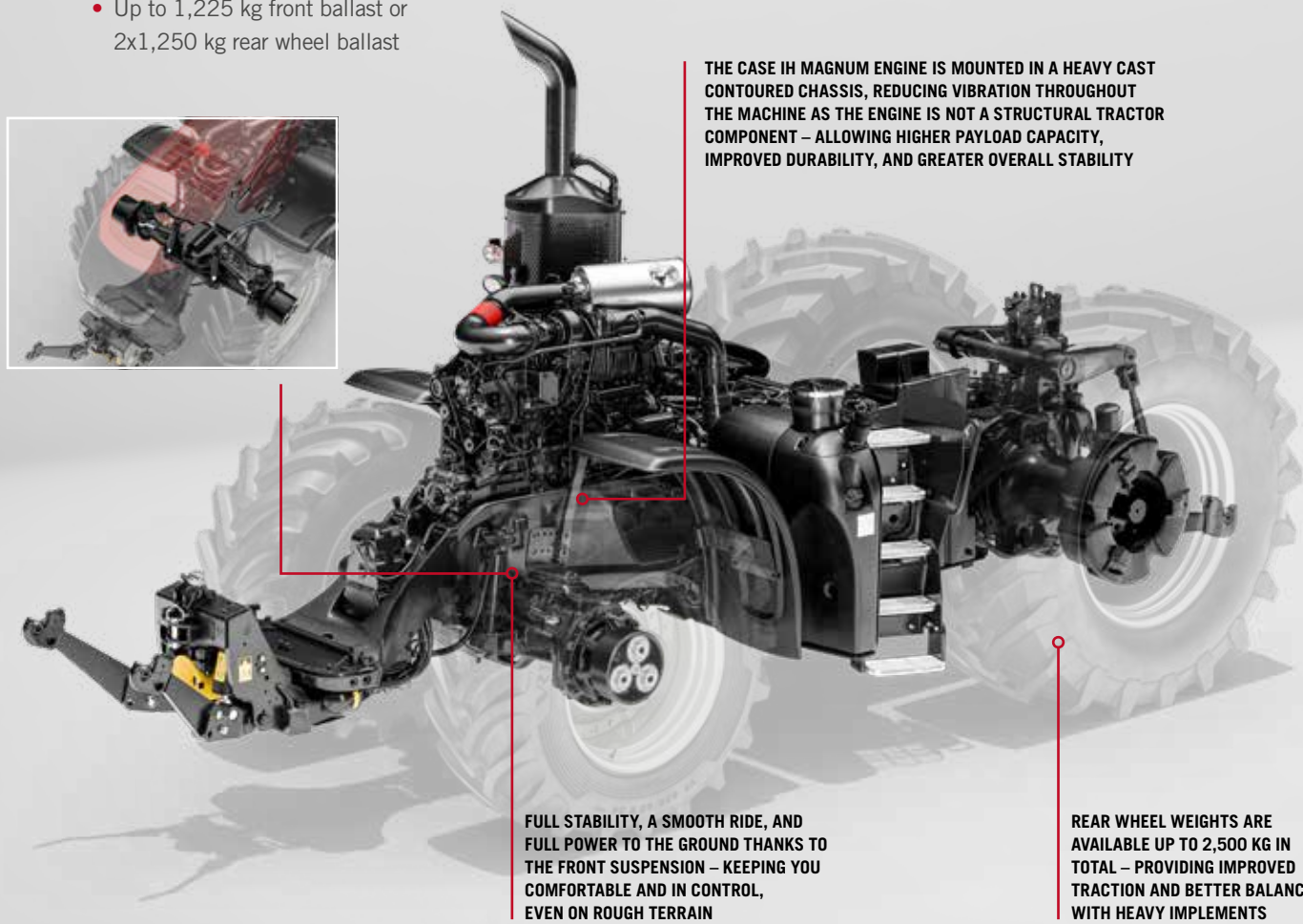

FULL STABILITY, A SMOOTH RIDE, AND FULL POWER TO THE GROUND THANKS TO THE FRONT SUSPENSION – KEEPING YOU COMFORTABLE AND IN CONTROL, EVEN ON ROUGH TERRAIN

REAR WHEEL WEIGHTS ARE AVAILABLE UP TO 2,500 KG IN TOTAL – PROVIDING IMPROVED TRACTION AND BETTER BALANCE WITH HEAVY IMPLEMENTS



2,550 mm



## PERFECT DIMENSIONS

With an overall width of just 2,550 mm, the Magnum delivers full stability while staying within standard road limits – compact, compliant, and ready for any field or transport task.

## POWERFUL, AGILE, MANOEUVERABLE

Welcome to first class

It pays to have experience building large tractors. Case IH has created the new Magnum to work long hours under the toughest conditions. Robust engineering and the right drive train handle the heaviest loads with ease. Every single axle component was developed at our Case IH plant in Racine, USA, and put through its paces.

### GETTING POWER TO THE GROUND

Tyres are available up to a diameter of 2.18 m and a width of 900 mm to maximise traction while minimising soil compaction. The long wheel base of up to 3,155 mm certainly helps get power where it's needed, as does the factory installed ballasting option with front ballast up to 1,225 kg and rear wheel weights up to 2,500 kg.

### AXLES DEVELOPED IN-HOUSE

Case IH offers heavy-duty axles for each model, guaranteeing superior stability and high payloads. The category 5 HD rear axle and the category 5 front axle with optional suspension are robust versions with high payload capacity.

### EXCELLENT MANOEUVERABILITY

Thanks to valuable customer feedback, we have developed an advanced assisted braking system to reduce the Magnum's turn radius and protect headland soil, automatically applying the rear brakes depending on your steering angle.

### DRIVING YOU FORWARD

With quick set buttons in the armrest, it is easy to activate auto diff lock and auto 4WD without navigating submenus. Some options include:

- Automatic deactivation of the differential lock depending on the position of the rear 3 point linkage
- Automatic deactivation of differential lock when a certain degree of turn is reached

# POWER TO THE GROUND

The fully-integrated solution

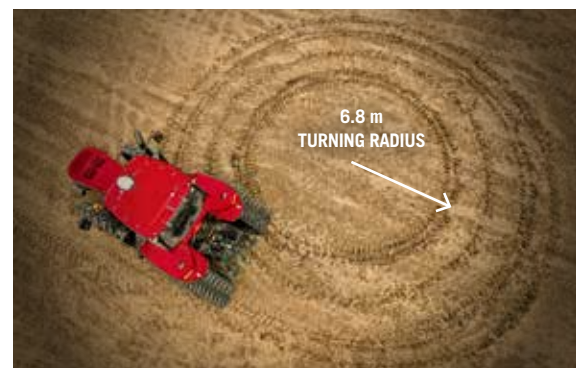

As a farmer, you know how important the soil is for agriculture in general and your operation in particular. It is the basis for dense planting and high yields. We at Case IH know that your most valuable resource needs to be treated carefully. This goal and our expertise in building track drives led us to combine all the advantages of a tracked machine with the best of a standard tractor. The Magnum Rowtrac offers maximum soil contact and top traction without sacrificing the ride quality or manoeuvrability of a wheeled tractor.

## + 6.8 M RADIUS

Rowtrac's unique track design shortens turning radius for faster, smoother headland turns with less soil disturbance.

## + HOMOLOGATION

Full homologation for Europe

## + FOOTPRINT

Rowtrac delivers more power with a larger footprint, meaning lower ground pressure for stronger traction.

## + MODELS

Available on Magnum 385 CVXDrive and 405 PowerDrive

## + POWER

Rowtrac ensures 100% power transfer through its positive drive system – delivering consistent traction, even under heavy draft loads or tough field conditions.

## + STEERING SYSTEM

New brake-assisted steering system now standard on Magnum Rowtrac – providing tighter control, smoother headland turns, and improved manoeuvrability under load.

## THE BEST OF BOTH WORLDS

The Case IH Quadtrac laid the groundwork, the Magnum Rowtrac is continuing the story - tracks up to 762 mm wide are available to increase surface contact. The combination of wheels and tracks ensure 4 independent points of contact to the ground for better traction, perfect weight distribution and better soil protection in any conditions.

## UNIQUE DESIGN

The track system was designed to integrate into the chassis from the beginning. Aftermarket solutions are not able to guarantee this level of power, loading capacity and ground clearance. The height of the track model is also the same as the wheeled version. With a top permissible speed of 40 kph and a transport width meeting EU regulations, your street journeys are quick and comfortable.



# COMMITTED TO THE EARTH

We protect your most important resource

## TRACTION, NO/LESS SLIPPAGE

The three suspended track rollers ensure that the weight of the tractor is evenly distributed over the whole surface of the track, following every contour on uneven ground. Get effective traction and minimise soil compaction even when pulling the heaviest loads. This is one of the biggest differences to machines with just one track on each side for two points of contact to the ground, which usually only generates effective traction from the back end. Rowtrac grips with four contact points.

## SKY-HIGH ADVANTAGES, BUT DOWN TO EARTH

Case IH engineers analysed the weaknesses of standard tracked tractors very carefully. From this analysis came the roller design of the Magnum Rowtrac. Whereas twin-track tractors quickly lose ground contact, the Rowtrac's oscillation with its +/- 10 degree tilt plus the suspended front axle allow Magnum Rowtrac to follow the contours of uneven ground for perfect weight distribution, diesel efficiency, surface contact and traction. The result - maximum soil protection.

## AS MANOUEVERABLE AND GENTLE ON THE SOIL AS A WHEELED TRACTOR

The Magnum Rowtrac's strengths aren't limited to traction and footprint - tight turns in the headland are yet another highlight. Thanks to brake assisted steering and a unique track system design with higher deflection rollers, the Magnum Rowtrac turns without rutting, berming, or smearing the soil. Profit from a flat, easy-to-level track in the next cultivation step.

## SUPERIOR UNDER EVERY CONDITION

Unlike other tracked tractors, the Rowtrac has a full differential lock on the front and rear axle so it always maintains traction even in the wettest conditions. With its excellent weight distribution and the large area of ground contact, the Rowtrac stays in control with rear hitch implements too. Pulling heavy loads around corners poses no problem for the Magnum Rowtrac. This is where other two-track solutions have to throw in the towel.

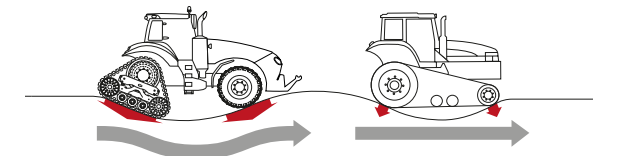
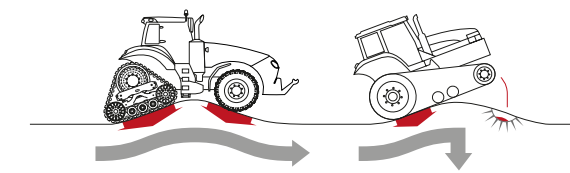

**ROWTRAC'S OSCILLATION AND SUSPENDED FRONT AXLE KEEP ALL TRACKS IN CONTACT WITH THE GROUND – ENSURING PERFECT WEIGHT DISTRIBUTION, MAXIMUM TRACTION, AND GREATER FUEL EFFICIENCY ON UNEVEN TERRAIN**

# HIGH-PERFORMANCE HYDRAULICS SYSTEM

Our competitors aren't the only ones to feel the pressure

## POWER HAS A NEW NAME: MAGNUM

Magnum's advanced hydraulics system raises the bar again: choose from a selection of two different high performance pumps with flowrates of 221 l/min (single pump) up to an amazing 358 l/min (twin pump). The dual axial piston pump version is especially suited to constant operation of power-hungry implements.

## WELL-EQUIPPED

A Power Beyond connection with load sensing capabilities and up to 6 electro-hydraulic remote valves in the rear plus 3 mid-mounted remotes permit the use of complex implements.

## ADVANTAGES

- Industry exclusive colour changing remote valve switches
- Up to 10,929 kg lift capacity at the rear
- Up to 4,070 kg front lift capacity
- Up to 358 l/min flow for high demand implements
- Up to 6 electro-hydraulic remote valves in the rear
- Up to 3 electro-hydraulic mid mounted remote valves
- Automatic trailer axle lock function

## YOU'VE NEVER HAD SO MUCH FREEDOM

The controls for the remote valves set a new standard in configurability and comfort. Use the high definition Pro 1200 monitor to assign up to 4 remote valves to hot keys on the Multicontroller, or on the new joystick. The backlit toggle switches change colour depending on which remote valve has been assigned to them - another Magnum first. This simplifies operation.

## WE KEEP LIFTING WHEN OTHERS GET TIRED

The category 4 heavy-duty rear hydraulics with electronic hitch control provide up to 10,929 kg lift capacity so that Magnum can work with heavier implements. Active cushion ride control prevents the implements from pitching and bouncing, increasing road transport drive quality.



THE JOYSTICK OFFERS PRECISE FINGERTIP CONTROL OF BOTH FRONT AND REAR HITCH FUNCTIONS – FOR SMOOTHER OPERATION.

FENDER-MOUNTED CONTROLS FOR HYDRAULICS, PTO, AND A REAR REMOTE PROVIDE CONVENIENT OPERATION FROM OUTSIDE THE CAB.



NEW ELECTROHYDRAULIC REMOTE VALVES DELIVER HIGHER FLOW AND FASTER RESPONSE WITH ENHANCED DURABILITY.



# MASSIVE POWER OUTPUT AT THE PTO

## POWER HAS A NEW NAME: MAGNUM

With dual-speed rear PTO and an optional front PTO, the Magnum delivers unmatched flexibility. Operators can power a wide range of implements – front and rear – for greater efficiency, fewer passes, and maximum productivity in every season.

## INTELLIGENT AND EASY TO CONTROL

From automatic PTO activation on headlands to external fender controls, the Magnum PTO is designed for intuitive operation. Front and rear auto PTO functions simplify workflows, protect the driveline, and let the operator stay focused on productivity rather than manual switching.

## ADVANTAGES

- Runs at **maximum engine power** for best performance at both 540 and 1,000 rpm.
- **Soft-start hydraulic clutch** for smoother operation and reduced component wear.
- **Auto PTO** automatically engages/disengages at headlands – saving time and preventing shaft damage.
- **External controls** on both rear fenders for safe, easy implement operation outside the cab.
- **Front PTO option** with electrohydraulic actuation and dedicated cooling for maximum durability.

# SEE MORE. WORK SMARTER. ANYTIME.

Advanced LED lighting for maximum visibility and precision – day or night.

## MAXIMUM PRODUCTIVITY - EVEN AFTER DARK

The Magnum's optimised lighting package turns night into day. Up to 20 high-performance LED lights provide a wide, even field of vision around the entire tractor and implement. Whether working long hours or navigating uneven terrain, operators benefit from clearer visibility, greater safety, and higher productivity – whenever the job demands it.



CONFIGURABLE CONTROL SWITCHES ON THE ARMREST WITH CHANGING COLOURS ENABLE THE INDIVIDUAL ASSIGNMENT OF THE REAR CONTROL UNITS



ILLUMINATED CONTROLS ENSURE CLEAR VISIBILITY AND INTUITIVE OPERATION AT NIGHT – KEEPING EVERY FUNCTION WITHIN EASY REACH, NO MATTER THE CONDITIONS.

# INTEGRATED TECH EFFICIENCY

Case IH Precision Technology systems revolutionised precision farming in 1995, allowing farmers to monitor the entire crop production cycle.

With Precision Technology solutions, farmers can increase profits through repeatable accuracy, lower operating costs and reduced overlaps.

## A PRECISION SOLUTION FOR EVERY NEED

Case IH offers a number of precision farming signals with varying levels of accuracy, so that you can choose what's best for your operation.

### RTK+

- Pass to pass: 1.5 cm
- Repeatable: 1.5 cm

### AFS1

- Pass to pass: 15 cm



## PRECISE AND REPEATABLE AUTOMATED STEERING

**AccuGuide** is a highly accurate auto guidance system designed to maintain parallel swaths with precision down to 1.5 cm. Choose from various guidance patterns including field, circle, curved, heading, spiral and straight.

- Fewer “skips” and “overlaps” for more precise planting, fertilising and tilling
- Less compaction for higher yields
- Faster field speeds to reduce your time on the job
- Reduced operator stress and fatigue



## SMART HEADLAND TURNS

Our **AccuTurn** technology combines headland management and headland steering processes. Turning radius, speed, and implement control when turning on headlands is automated and optimised, resulting in increased efficiency and improved comfort.

- Automation optimises headland turns and field layouts
- Improves the repeatability and the overall efficiency
- Minimises operator error and reduces fatigue
- Can be combined with HMC II (AccuTurn Pro)



## ISOBUS III

With ISOBUS III, an implement can easily be controlled directly from the Pro 1200 monitor. With ISOBUS III, the implement automatically controls aspects of the Magnum.



## AUTOMATE YOUR HEADLAND SEQUENCE

The **Headland Management Control II** system assists drivers when turning at the headland by allowing them to program each step by time or distance. It can also trigger other automated functions, such as lowering engine speed after lifting the implement.

- Automates workflows for less driver fatigue and higher productivity
- HMC II turns a repetitive manual task into an automated pinpoint process



**CONNECT.  
VIEW.  
MANAGE.**



FieldOps is a simplified, all-in-one platform for all your Case IH and other brand equipment.

Get access to real-time data and insights, including real-time monitoring, precise equipment location and duty status, estimated job completion time, and more.

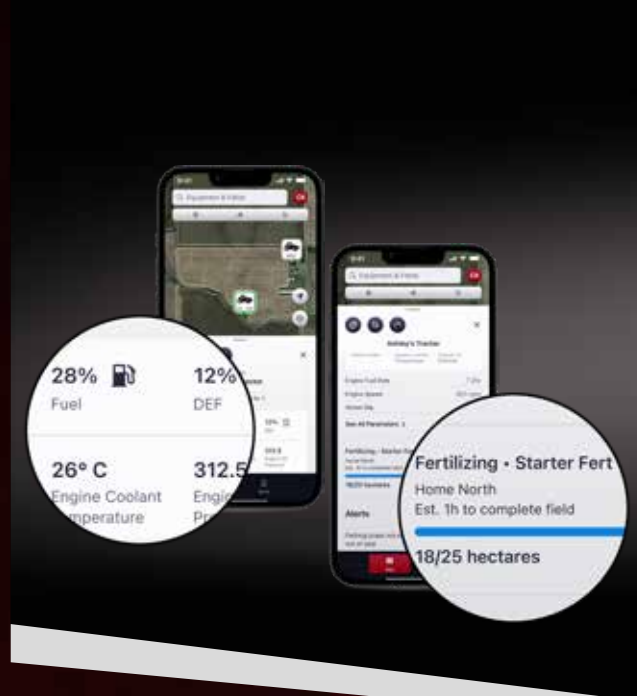

## REAL-TIME MACHINE MONITORING

- Get precise equipment location and duty status.
- Monitor task completion and view 24-hour machine history.
- For a specific job, the robust performance data from FieldOps tells you how much area is left in the field and gives you an estimated time to completion.

## MACHINE PERFORMANCE TRACKING

- Improve your fleet's efficiency from anywhere.
- Monitor every detail of your fleet to make real-time decisions.
- Build your setup with your choice of over 50 real-time parameters, including:
  - telematics
  - work status
  - fuel and DEF consumption
  - engine hours and more...

## DATA VISUALISATION

- Quickly view the activities for a given field and choose which data layer to visualise.
- Turn agronomic data layers into prescriptions, run agronomic reports and create manual agronomic data layers.
- Set-up data integration between Case IH equipment and third-party systems to streamline data collection and analysis, providing a holistic view of your farm operations.
- Easily find what you're looking for by toggling between tabs or using powerful search and quick filters.

## SUPPORT & SERVICE REMOTELY

### VIEW IN-CAB SCREEN REMOTELY

No matter where they are, a farm manager or dealer can easily see exactly what the operator is seeing on the screen in the tractor cab.

### REMOTE SERVICE SUPPORT

Work with your local Case IH dealer to remotely diagnose maintenance and service issues and identify the parts you need to stay up and running.



Launch a remote display session from your mobile phone and view what is displayed on screen to provide guidance to operators and offer near real-time adjustments from anywhere.

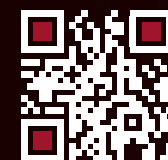

CREATE A FREE ACCOUNT TO ACCESS ALL CASE IH FIELDOPS FEATURES!



Download the app



# SAFE **GUARD** CONNECT

## PROTECT YOUR INVESTMENT, ENHANCE YOUR PRODUCTIVITY

### SAFE **GUARD** WARRANTY

#### PROTECT YOUR INVESTMENT

SAFEGUARD WARRANTY allows you to protect your investment from exposure to risk of unexpected repair cost. Farm with peace of mind, keep operating cost under control and, at same time, increase machine resale value.

**INCREASED  
RESALE  
VALUE**

### OPERATOR **TRAINING**

#### KNOWLEDGE IS POWER

Unleash the full potential of your machine: Reach maximum performance and avoid improper use of your new Case IH machine. Our professional training for operators delivered by your Case IH Dealer focuses on the new functionalities of your machine.

**INCREASED  
OPERATOR  
SAFETY AND  
PERFORMANCE**

### PRE-SEASON **CHECK**

#### PEACE OF MIND

Case IH dealer technicians offer a Pre-Season Check to keep your machines in good shape and prevent downtime. The inspection covers a thorough set of checkpoints, and the technician will suggest ways to optimise machine performance based on the history report data.

**MAXIMISE  
MACHINE USE,  
PREVENT  
DOWNTIME**

**INCREASED  
PRODUCTIVITY  
PER HECTARE**

### FieldOps

#### CONNECTIVITY INCLUDED

Use precision farming data and manage your fleet: Case IH FieldOps provides you with information about recent operations and lets you monitor machine status.

**INCREASED  
PRODUCTIVITY,  
FASTER REPAIR**

### CONNECT **ROOM**

#### CONNECT ROOM: YOUR PIT CREW

Connect Room continuously monitors machines, proactively identifies potential issues, and alerts dealers for quick help, maximising productivity and minimising downtime.



THE COOLING PACKAGE SWINGS OUT FOR QUICK, EASY ACCESS – SIMPLIFYING CLEANING AND MAINTENANCE TO KEEP PERFORMANCE AT ITS PEAK.

THE INTEGRATED SERVICE PLATFORM PROVIDES SAFE, CONVENIENT ACCESS FOR MAINTENANCE, AND WINDSCREEN CLEANING – DESIGNED FOR EVERYDAY EFFICIENCY.

# UPTIME IS ALWAYS ON OUR MIND

Because it's always on yours

## MAXIMUM UPTIME, MINIMUM SERVICE COSTS

The Magnum keeps you working, reducing maintenance and costly downtime to a minimum. The long 600 hour service intervals are just one of the many features that drive down your maintenance and service costs and keeps you longer in the field.



# PARTS AND SERVICES

Solutions for your farming

Our professional dealer network backed up by local Case IH teams, industry-leading Case IH support tools, modern training methods, best-in-class replacement parts, support and logistics performance. All you need for excellent all-encompassing after-sales service to keep you farming.

## GENUINE PARTS THE IDEAL CHOICE

Our wide range of top quality genuine parts can help maintain the full potential of your machine, season after season, guaranteeing top performance, utmost productivity and high residual value.

## REMAN PARTS REMANUFACTURED

Cutting-edge technology, tailored tooling, equipment and stringent quality testing allow us to remanufacture essential components of your machine to the highest standards, ensuring the same performance as new parts.

## ACCESSORIES LINE BUSINESS SOLUTIONS

Our engineers also develop solutions to cover every one of your individual demands, packaged into kits and designed to help improve business efficiency. Your Case IH dealer offers a host of partner-branded tools, small parts and accessories provided by selected partner suppliers.

## SAFEGUARD WARRANTY PROTECT YOUR INVESTMENT

The Case IH extended warranty program offers the same conditions as the first year. SAFEGUARD WARRANTY allows you to protect your investment from exposure to risk of unexpected repair cost, farm with peace of mind, keep operating costs under control and, at same time, increase machine resale value.

## SAFEGUARD MAINTENANCE PREVENT AND PERFORM

This comprehensive Case IH planned maintenance agreement was developed to maximise your Case IH equipment's performance, lifespan and resale value, while reducing operating costs.



## OPTIMAL FINANCING SOLUTION FOR EVERY INVESTMENT

CNH Capital is the financing company for Case IH. Our employees are financial experts and have many years of experience in agriculture. We not only know about Case IH products and the market – we also understand the individual requirements of your operations. Therefore we are always able to offer you a financial solution for your new investments that is tailored specifically to your operational requirements. Our most important goal is improving the profitability of your investments!

\*ask your Case IH dealer for details, terms and conditions of Safeguard Warranty and Safeguard Maintenance for your new machine

MODELS	MAGNUM 355	MAGNUM 385	MAGNUM 405
<b>ENGINE FPT</b>			
Number of cylinders	6		
Type	Common Rail Diesel engine with 24 valves, turbocharged and intercooled		
Emission level	Tier 2		
Capacity [cm <sup>3</sup> ]	8,700		
Max. power ECE R120 Power Management <sup>1)</sup> [kW/hp(CV)]	410	423	423
Max. power ECE R120 [kW/hp(CV)]	390	417	423
... at engine speed [rpm]	1,800		
Rated power ECE R120 Power Management <sup>1)</sup> [kW/hp(CV)]	375	403	403
Rated power ECE R120 [kW/hp(CV)]	355	385	403
... at engine speed [rpm]	2,000		
Rated Power Growth [%]	9%	8%	5%
% Boost @ Peak	5%	1%	0%
Fuel tank capacity diesel PowerDrive / CVXDrive / Rowtrac	765 / 765 / 674		
<b>TRANSMISSION</b>			
21x5 PowerDrive 40 kph Eco or 50 kph Eco with brake-to-clutch	•	–	•
CVXDrive transmission, continuously variable from 0 to 40 kph Eco or 0 to 50 kph	•	•	–
Powershuttle - left and right hand	•		
Rear axle diff-lock type	Electro-hydraulic		
Service brake	Hydraulically operated multiple wet disc brake, self adjusting		
<b>POWER TAKE OFF</b>			
Engagement type	Electro-hydraulic		
Speeds standard (option)	1,000 (540 / 1,000)		
... at engine speed [rpm]	1,803		
Shaft type standard (option)	1 3/4" 20 splines (1 3/8" 6 splines (540 rpm) or 1 3/8" 21 splines (1,000 rpm) or 1 3/4" 20 splines (1,000 rpm))		
<b>FRONT HITCH AND PTO</b>			
Front PTO 1,000 speed @ 1,804 rpm	o		
Front hitch lift capacity [kg]	4,090		
<b>FRONT AXLE</b>			
Front axle category standard	Cat.5	Cat.5	Cat.5
Front axle suspension	•	•	•
Steering angle [°]	55		
Min. turning radius <sup>3)</sup> track setting 1,800 mm [m]	5.3		
<b>HYDRAULIC SYSTEM</b>			
System type	Variable displacement, pressure flow compensated pump		
Max. pump flow rate / high flow / twin flow [l/min]	PowerDrive: 236 / 358; CVXDrive: 221 / 335		
System pressure [bar]	210		
Control type	Electronic Hitch Control (EHC) with hitch ride control, optional hydraulic top link and automatic stabilizers optional		
Max. lift capacity [kg]	10,929	10,929	10,929
OECD lift capacity through range @ 610 mm [kg]	10,884	10,884	10,884
Max. number of rear remote valves	5 electronic remote valves standard, 6 optional - power beyond or low pressure return connection with individual remote		
Remote valve timer control	0 - 30 seconds on all models		
Category type	Cat IV	Cat IV	Cat IV
Slip control	•	•	•

<sup>1)</sup> Power Management is only available during hydraulic, mobile PTO and haulage application  
• Standard    o Option    – not available

<sup>2)</sup> Weight can vary according to tractor configuration

<sup>3)</sup> With standard tyres

<sup>4)</sup> Other tyres on request

MODELS	MAGNUM 355	MAGNUM 385	MAGNUM 405
<b>WEIGHT<sup>2)</sup></b>			
Approximate shipping weight standard / suspended front axle [kg]	11,800 / 12,400	11,800 / 12,400	11,800 / 12,400
Permissible total weight Cat.5 front axle [kg]	18,000	18,000	18,000
Max. permissible weight front Cat.5 front axle [kg]	7,760	7,760	7,760
Max. permissible weight rear axle [kg]	11,500	11,500	11,500
<b>DIMENSIONS<sup>3)</sup></b>			
A: Total length only carrier / front hitch / front weights [mm]	6,299 / 6,575 / 6,499	6,299 / 6,575 / 6,499	6,299 / 6,575 / 6,499
B: Total height [mm]	3,380	3,380	3,380
C: Total width (across rear fenders extension) [mm]	2,550	2,550	2,550
D: Wheel base [mm]	3,155	3,155	3,155
E: Height at centre of rear axle to highest point [mm]	2,475	2,475	2,475
F: Track setting front [mm]	1,524 - 2,240	1,524 - 2,240	1,524 - 2,240
rear [mm]	1,470 - 2,294	1,470 - 2,294	1,470 - 2,294
<b>STANDARD TYRES<sup>4)</sup></b>			
Front	600 / 70 R30	600 / 70 R30	600 / 70 R30
Rear	710 / 70 R42	710 / 70 R42	710 / 70 R42

MODELS	MAGNUM 385 ROWTRAC	MAGNUM 405 ROWTRAC
<b>WEIGHT<sup>2)</sup></b>		
Approximate shipping weight Cat. 5 / Cat. 5 suspended front axle [kg]	16,653 / 17,113	16,653 / 17,113
Permissible total weight [kg]	24,500	
<b>DIMENSIONS<sup>3)</sup></b>		
A: Total length only carrier / front hitch / front weights [mm]	6,015 / 6,295 / 6,225	6,015 / 6,295 / 6,225
B: Total height [mm]	3,450	3,450
C: Total width with 600 mm / 762 mm tracks [mm]	2,540 / 2,990	2,540 / 2,990
D: Wheel base [mm]	3,155	3,155
E: Height to centre of drivewheel [mm]	1,243	1,243
F: Track setting front [mm]	1,560 - 2,256	1,560 - 2,256
rear [mm]	1,470 - 2,294	1,470 - 2,294
<b>STANDARD TYRES<sup>4)</sup></b>		
Front	620 / 75 R30	620 / 75 R30
<b>TRACK</b>		
Available track width standard / option [mm]	610 / 762	610 / 762

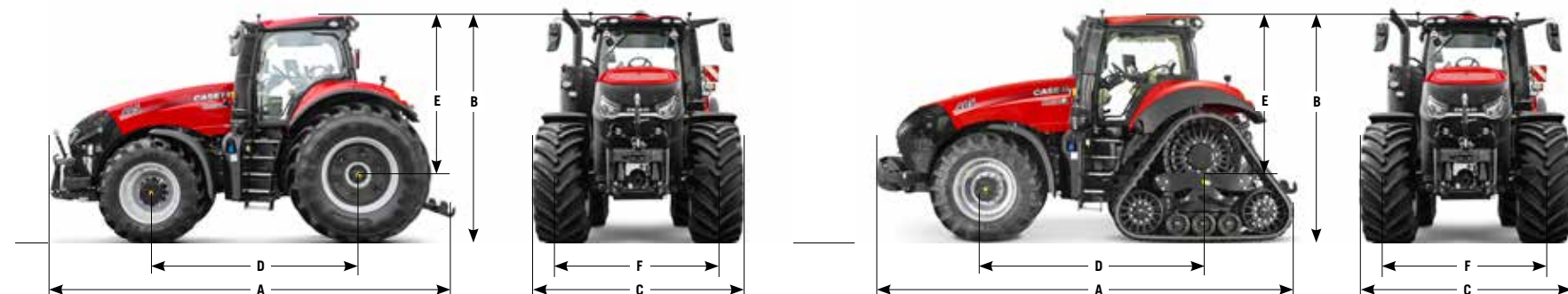



  
caseih.com

 Free phone: 00 800 22 73 44 00



Safety never hurts! Always read the Operator's Manual before working with any equipment. Inspect equipment before using it, and be sure it is operating properly. Follow the product safety signs, and use any safety features provided. This literature has been published for worldwide circulation. The standard and optional equipment and the availability of individual models may vary from one country to the next. Case IH reserves the right to undertake modifications without prior notice to the design and technical equipment at all times without this resulting in any obligation whatsoever to make such modifications to units already sold. Whilst every effort is made to ensure that the specifications, descriptions and illustrations in this brochure are correct at the time of going to press, these are also subject to change without prior notice. Illustrations may show optional equipment or may not show all standard equipment. Case IH recommends **AKCELA** lubricants.

Subscribe now  
for exclusive  
offers & updates

TP01 / SM / 12.2025 / Printed in Austria -  
Cod.No. CIH\_26\_Magnum-355-404\_Brochure\_CIS

**CASE IH**