

2 - SAFETY INFORMATION

Signal word definitions

Personal safety





This is the safety alert symbol. It is used to alert you to potential personal injury hazards. Obey all safety messages that follow this symbol to avoid possible death or injury.

Throughout this manual you will find the signal words DANGER, WARNING, and CAUTION followed by special instructions. These precautions are intended for the personal safety of you and those working with you.

Read and understand all the safety messages in this manual before you operate or service the machine.

 DANGER indicates a hazardous situation that, if not avoided, will result in death or serious injury.

 WARNING indicates a hazardous situation that, if not avoided, could result in death or serious injury.

 CAUTION indicates a hazardous situation that, if not avoided, could result in minor or moderate injury.

FAILURE TO FOLLOW DANGER, WARNING, AND CAUTION MESSAGES COULD RESULT IN DEATH OR SERIOUS INJURY.

Machine safety

NOTICE: Notice indicates a situation that, if not avoided, could result in machine or property damage.

Throughout this manual you will find the signal word Notice followed by special instructions to prevent machine or property damage. The word Notice is used to address practices not related to personal safety.

Information

NOTE: Note indicates additional information that clarifies steps, procedures, or other information in this manual.

Throughout this manual you will find the word Note followed by additional information about a step, procedure, or other information in the manual. The word Note is not intended to address personal safety or property damage.

Safety rules

General safety rules

Use caution when you operate the machine on slopes. Raised equipment, full tanks and other loads will change the center of gravity of the machine. The machine can tip or roll over when near ditches and embankments or uneven surfaces.

Never permit anyone other than the operator to ride on the machine.

Never operate the machine under the influence of alcohol or drugs, or while you are otherwise impaired.

When digging or using ground-engaging attachments, be aware of buried cables. Contact local utilities to determine the locations of services.

Pay attention to overhead power lines and hanging obstacles. High voltage lines may require significant clearance for safety.

Hydraulic oil or diesel fuel leaking under pressure can penetrate the skin, causing serious injury or infection.

- DO NOT use your hand to check for leaks. Use a piece of cardboard or paper.
- Stop the engine, remove the key, and relieve the pressure before you connect or disconnect fluid lines.
- Make sure that all components are in good condition. Tighten all connections before you start the engine or pressurize the system.
- If hydraulic fluid or diesel fuel penetrates the skin, seek medical attention immediately.
- Continuous long term contact with hydraulic fluid may cause skin cancer. Avoid long term contact and wash the skin promptly with soap and water.

Keep clear of moving parts. Loose clothing, jewelry, watches, long hair, and other loose or hanging items can become entangled in moving parts.

Wear protective equipment when appropriate.

DO NOT attempt to remove material from any part of the machine while it is being operated or while components are in motion.

General maintenance safety

Keep the area used for servicing the machine clean and dry. Clean up spilled fluids.

Service the machine on a firm, level surface.

Install guards and shields after you service the machine.

Close all access doors and install all panels after servicing the machine.

Make sure that all guards and shields are in good condition and properly installed before you operate the machine. Never operate the machine with shields removed. Always close access doors or panels before you operate the machine.

Dirty or slippery steps, ladders, walkways, and platforms can cause falls. Make sure these surfaces remain clean and clear of debris.

A person or pet within the operating area of a machine can be struck or crushed by the machine or its equipment. DO NOT allow anyone to enter the work area.

Raised equipment and/or loads can fall unexpectedly and crush persons underneath. Never allow anyone to enter the area underneath raised equipment during operation.

Never operate the engine in enclosed spaces as harmful exhaust gases may build up.

Before you start the machine, be sure that all controls are in neutral or park lock position.

Start the engine only from the operator's seat. If you bypass the safety start switch, the engine can start with the transmission in gear. Do not connect or short across terminals on the starter solenoid. Attach jumper cables as described in the manual. Starting in gear may cause death or serious injury.

Always keep windows, mirrors, all lighting clean to provide the best possible visibility while you operate the machine.

Operate controls only when seated in the operator's seat, except for those controls expressly intended for use from other locations.

Before you leave the machine:

1. Park the machine on a firm, level surface.
2. Lower the attachment to the ground.
3. Put all controls in neutral position.
4. Place the gate lock lever in central position.
5. Turn off the engine and remove the key.

Do not attempt to clean, lubricate, clear obstructions, or make adjustments to the machine while it is in motion or while the engine is running.

Always make sure that working area is clear of tools, parts, other persons and pets before you start operating the machine.

Unsupported hydraulic cylinders can lose pressure and drop the equipment, causing a crushing hazard. Do not leave equipment in a raised position while parked or during service, unless the equipment is securely supported.

Jack or lift the machine only at jack or lift points indicated in this manual.

Incorrect towing procedures can cause accidents. When you tow a disabled machine follow the procedure in this manual. Use only rigid tow bars.

Stop the engine, remove the key, and relieve pressure before you connect or disconnect fluid lines.

Stop the engine and remove the key before you connect or disconnect electrical connections.

Scalding can result from incorrect removal of coolant caps. Cooling systems operate under pressure. Hot

coolant can spray out if you remove a cap while the system is hot. Allow the system to cool before you remove the cap. When you remove the cap, turn it slowly to allow pressure to escape before you completely remove the cap.

Replace damaged or worn tubes, hoses, electrical wiring, etc.

The engine, transmission, exhaust components, and hydraulic lines may become hot during operation. Take care when you service such components. Allow surfaces to cool before you handle or disconnect hot components. Wear protective equipment when appropriate.

When welding, follow the instructions in the manual. Always disconnect the battery before you weld on the machine. Always wash your hands after you handle battery components.

Fire and explosion prevention

Fuel or oil that is leaked or spilled on hot surfaces or electrical components can cause a fire.

Crop materials, trash, debris, bird nests, or flammable material can ignite on hot surfaces.

Always have a fire extinguisher on or near the machine.

Make sure that the fire extinguisher(s) is maintained and serviced according to the manufacturer's instructions.

At least once each day and at the end of the day, remove all trash and debris from the machine especially around hot components such as the engine, transmission, exhaust, battery, etc. More frequent cleaning of your machine may be necessary depending on the operating environment and conditions.

At least once each day, remove debris accumulation around moving components such as bearings, pulleys, belts, gears, cleaning fans, etc. More frequent cleaning of your machine may be necessary depending on the operating environment and conditions.

General battery safety

Always wear eye protection when you work with batteries.

Do not create sparks or have open flame near a battery.

Ventilate the area when you charge a battery or use a battery in an enclosed area.

Disconnect the negative — terminal first and reconnect the negative — terminal last.

When you weld on the machine, disconnect both terminals of the battery.

Do not weld, grind, or smoke near a battery.

Inspect the electrical system for loose connections and frayed insulation. Repair or replace loose or damaged parts.

Do not store oily rags or other flammable material on the machine.

Do not weld or flame cut any items that contain flammable material. Clean items thoroughly with non-flammable solvents before welding or flame-cutting.

Do not expose the machine to flames, burning brush, or explosives.

Promptly investigate any unusual smells or odors that may occur during operation of the machine.

Before performing maintenance for electrical systems or electric welding, always place the key of the battery master switch in "O" (Off) position or disconnect the negative — terminal of the batteries, in order to cut off the electric circuit.

When you use auxiliary batteries or connect jumper cables to start the engine, use the procedure shown in the operator's manual. Do not short across terminals.

Follow the manufacturer's instructions when you store and handle batteries.

Battery post, terminals, and related accessories contain lead and lead compounds. Wash hands after handling.

Battery acid causes burns. Batteries contain sulfuric acid. Avoid contact with skin, eyes, or clothing. Antidote (external): Flush with water. Antidote (eyes): flush with water for 15 minutes and seek medical attention immediately.

Antidote (internal) : Drink large quantities of water or milk. Do not induce vomiting. Seek medical attention immediately.

Keep out of reach of children and other unauthorized persons.

Seat belts

Seat belts must be worn at all times.

Seat belt inspection and maintenance:

- Keep seat belts in good condition.
- Keep sharp edges and items that can cause damage away from the belts.
- Periodically check belts, buckles, retractors, tethers, slack take-up system, and mounting bolts for damage and wear.
- Replace all parts that have damage or wear.

- Replace belts that have cuts that can make the belt weak.
- Check that bolts are tight on the seat bracket or mounting.
- If the belt is attached to the seat, make sure that the seat or seat brackets are mounted securely.
- Keep seat belts clean and dry.
- Clean belts only with soap solution and warm water.
- Do not use bleach or dye on the belts because this can make the belts weak.

Operator protective structure

Your machine is equipped with an operator protective structure, such as: a Roll Over Protective Structure (ROPS), Falling Objects Protective Structure (FOPS), or a cab with a ROPS. A ROPS may be a can frame or a two-posted or four-posted structure used for the protection of the operator to minimize the possibility of serious injury. The mounting structure and fasteners forming the mounting connection with the machine are part of the ROPS.

The protective structure is a special safety component of your machine.

DO NOT attach any device to the protective structure for pulling purposes. DO NOT drill holes to the protective structure.

The protective structure and interconnecting components are a certified system. Any damage, fire, corrosion, or modification will weaken the structure and reduce your protection. If this occurs, THE PROTECTIVE STRUCTURE MUST BE REPLACED so that it will provide the same protection as a new protective structure. Contact your dealer for protective structure inspection and replacement.

After an accident, fire, tip over, or roll over, the following MUST be performed by a qualified technician before returning the machine to field or job-site operations:

- The protective structure MUST BE REPLACED.
- The mounting or suspension for the protective structure, operator's seat and suspension, seat belts and mounting components, and wiring within the operator's protective system MUST be carefully inspected for damage.
- All damaged parts MUST BE REPLACED.

DO NOT WELD, DRILL HOLES, ATTEMPT TO STRAIGHTEN, OR REPAIR THE PROTECTIVE STRUCTURE. MODIFICATION IN ANY WAY CAN REDUCE THE STRUCTURAL INTEGRITY OF THE STRUCTURE, WHICH COULD CAUSE DEATH OR SERIOUS INJURY IN THE EVENT OF FIRE, TIP OVER, ROLL OVER, COLLISION, OR ACCIDENT.

Seat belts are part of your protective system and must be worn at all times. The operator must be held to the seat inside the frame in order for the protective system to work.

Air-conditioning system

The air-conditioning system is under high pressure. Do not disconnect any lines. The release of high pressure can cause serious injury.

The air-conditioning system contains gases that are harmful to the environment when released into the atmosphere. Do not attempt to service or repair the system.

Only trained service technicians can service, repair, or recharge the air-conditioning system.

Personal Protective Equipment (PPE)

Wear Personal Protective Equipment (PPE) such as hard hat, eye protection, heavy gloves, hearing protection, protective clothing, etc.

Do Not Operate tag

Before you start servicing the machine, attach a 'Do Not Operate' warning tag to the machine in an area that will be visible.

Hazardous chemicals

If you are exposed to or come in contact with hazardous chemicals you can be seriously injured. The fluids, lubricants, paints, adhesives, coolant, etc. required for the function of your machine can be hazardous. They may be attractive and harmful to domestic animals as well as humans.

Material Safety Data Sheets (MSDS) provide information about the chemical substances within a product, safe handling and storage procedures, first aid measures, and procedures to take in the event of a spill or accidental release. MSDS are available from your dealer.

Before you service your machine check the MSDS for each lubricant, fluid, etc. used in this machine. This information indicates the associated risks and will help you service the machine safely. Follow the information in the

MSDS, and on manufacturer containers, as well as the information in this manual, when you service the machine.

Dispose of all fluids, filters, and containers in an environmentally safe manner according to local laws and regulations. Check with local environmental and recycling centers or your dealer for correct disposal information.

Store fluids and filters in accordance with local laws and regulations. Use only appropriate containers for the storage of chemicals or petrochemical substances.

Keep out of reach of children or other unauthorized persons.

Applied chemicals require additional precautions. Obtain complete information from the manufacturer or distributor of the chemicals before you use them.

Utility safety

When digging or using ground-engaging equipment, be aware of buried cables and other services. Contact your local utilities or authorities, as appropriate, to determine the locations of services.

Make sure that the machine has sufficient clearance to pass in all directions. Pay special attention to overhead power lines and hanging obstacles. High voltage lines may require significant clearance for safety. Contact local authorities or utilities to obtain safe clearance distances from high voltage power lines.

Retract raised or extended components, if necessary. Remove or lower radio antennas or other accessories. Should a contact between the machine and an electric

power source occur, the following precautions must be taken:

- Stop the machine movement immediately.
- Apply the parking brake, stop the engine, and remove the key.
- Check if you can safely leave the cab or your actual position without contact with electrical wires. If not, stay in your position and call for help. If you can leave your position without touching lines, jump clear of the machine to make sure that you do not make contact with the ground and the machine at the same time.
- Do not permit anyone to touch the machine until power has been shut off to the power lines.

Electrical storm safety

Do not operate machine during an electrical storm.

If you are on the ground during an electrical storm, stay away from machinery and equipment. Seek shelter in a permanent, protected structure.

If an electrical storm should strike during operation, remain in the cab. Do not leave the cab or operator's platform. Do not make contact with the ground or objects outside the machine.

Mounting and dismounting

Mount and dismount the machine only at designated locations that have handholds, steps, and/or ladders.

Do not jump off of the machine.

Make sure that steps, ladders, and platforms remain clean and clear of debris and foreign substances. Injury may result from slippery surfaces.

Face the machine when you mount and dismount the machine.

Maintain a three-point contact with steps, ladders, and handholds.

Do not use the controls or accessories as handholds when you enter or exit the cab.

Never mount or dismount from a moving machine.

Working at heights

When the normal use and maintenance of the machine requires you to work at heights:

- Correctly use installed steps, ladders, and railings.
- Never use ladders, steps, or railings while the machine is moving.

- Do not stand on surfaces that are not designated as steps or platforms.

Do not use the machine as a lift, ladder, or platform for working at heights.

Lifting and overhead loads

Never use loader buckets, forks, etc. or other lifting, handling, or digging equipment to lift persons.

Loader buckets, forks, etc. or other lifting, handling, or digging equipment and its load will change the center of gravity of the machine. This can cause the machine to tip on slopes or uneven ground.

Do not use raised equipment as a work platform.

Load items can fall off the loader bucket or lifting equipment and crush the operator. Care must be taken when lifting a load. Use proper lifting equipment.

Know the full area of movement of the machine and equipment and do not enter or permit anyone to enter the area of movement while the machine is in operation.

Do not lift load higher than necessary. Lower loads to transport. Remember to leave appropriate clearance to the ground and other obstacles.

Never enter or permit anyone to enter the area underneath raised equipment. Equipment and/or loads can fall unexpectedly and crush persons underneath it.

Equipment and associated loads can block visibility and cause an accident. Do not operate with insufficient visibility.

Do not leave equipment in raised position while parked or during service, unless securely supported. Hydraulic cylinders must be mechanically locked or supported if they are left in a raised position for service or access.

Before using the machine

- Avoid loose fitting clothing, loose or uncovered long hair, jewelry or any other items which could get caught up in machinery.
- Different types of job will require different types of protective equipment. Items such as hard hats, safety shoes, heavy gloves, reflector type jackets, respirators, ear protection and eye protection may be required. Before starting a job, determine what protective equipment will be necessary. Use this equipment at all times.
- Do not attempt to operate this machine unless you have first read and perfectly understood the safety messages and instructions appearing in this manual.
- Operating the machine requires full attention and care on the part of the operator can avoid accidents. Get to know the machine's possibilities and limitations and the working space required. There are areas of poor visibility in the working range of the machine. Have someone guide you for all areas where visibility is not perfect.
- Grease, oil, mud or (in winter) ice on the steps and access handles can cause accidents. Make sure they are kept clean at all times.
- Every day, inspect the machine to detect any signs of hydraulic fluid leakage. Tighten the connections or replace any defective components as necessary.
- Remove any obstructions which hinder visibility. Keep the windshield, rear view mirror and windows clean at all times.
- Make sure the windshield wiper works correctly.
- Make sure you are perfectly familiar with hand signals in daily use on the worksite so as to be able to obtain help with tight manoeuvres or when carrying out operations where visibility is poor.
- Before undertaking any travel or working operations during hours of darkness, make sure the lighting and signaling equipment is fully operative.
- Before any travel operation, make sure that the doors and hoods are properly latched.
- Check that no tools or other items have been left on the machine (be it on the undercarriage or the upperstructure) or in the operator's compartment.
- The operator must be alone on the machine at all times. Do not allow anyone to stand on or around the machine.
- To get in or out of the cab, it is imperative that the upperstructure frame is in line with the undercarriage.

- When alighting from or getting into the operator's compartment, always face the machine and use the steps and access handles.
- Be sure you know the position and function of each control. Incorrect operation of the controls can cause serious injuries.
- Check all controls and safety devices in a safe, open area before starting work.
- Keep away from dangerous areas such as ditches, overhangs, rocky areas, etc. Make a survey of the work-site and determine the possible dangers before using the machine.
- Before parking the machine, make sure that the ground is stable. Plan the worksite so that the ground is flat, hard and level.
- Before moving the machine to work in a new area, walk around to determine all possible causes of accidents there. Holes, obstacles, debris and other danger risks in the working area can cause serious injury.
- Be ready to meet emergencies. Always carry a first aid kit and if possible, fire extinguisher (not supplied) within easy reach on board. Make sure the fire extinguisher is regularly serviced in conformance with the manufacturer's instructions.
- Check the fastening of the main components: counterweight, turntable bearing and operator's compartment. In the event of problems, consult your CASE CONSTRUCTION Dealer.
- Make sure you understand the symbols used on the machine safety decals. Keep the decals clean so that they are perfectly legible at all times.
- Work out a means of convenient escape from the machine (emergency exit via the windshield or the rear window glass) in the event of the machine turning over or tipping over or the cab door being jammed.
- Make sure you are perfectly familiar with traffic regulations and special safety equipment requirements before transporting this machine on a public highway.
- When loading trucks, never swing the load over the truck cab.
- Before undertaking any travel on the job site, make sure the itinerary to be followed is completely safe. If bridges are to be crossed, make sure they are perfectly capable of supporting the weight of the machine.
- Always steer round large obstacles such as boulders, big trees, etc.

Quick coupler (optional)

- Every day, check that the locking bar functions correctly and that it is not fouled by foreign matter. Clean the locking system if necessary.
- If you are obliged to use the quick coupler with buckets not manufactured by CASE CONSTRUCTION, make sure the diameter of the pins and the width between the bucket lugs meet the dimensions needed to fit the quick coupler (pins, washers, bushings, etc.). Consult your CASE CONSTRUCTION Dealer.

Operating the machine

- When working on a public highway, use standard traffic signs and take into consideration the working range of the upperstructure and its attachments. Local or national regulations stipulate the number, type and location of reflector strips.
- Avoid running the engine in a confined space. If there is no alternative, proper ventilation must be provided at all times.
- Do not allow anyone else on the machine. The passenger could fall or cause an accident.
- Never operate the working or travel controls unless you are properly seated in the operator's seat with the seat belt correctly fastened.
- Before starting the engine, check the direction of travel (in forward drive, the reduction gears should be to the rear of the machine).
- Do not work near overhead high-voltage electric lines without checking beforehand that all necessary measures have been taken to respect the minimum distances:
Less than 57000 volts: **3 m (9.8 ft)**.
More than 57000 volts: **5 m (16.4 ft)**.
- Study the position of any existing pipelines or conduits before starting work. Electrical cables, gas and water pipes and other underground installations can cause serious injury.
- Always make allowance for working conditions (sloping or rough ground), the site and weather conditions when driving the machine.
- Do not allow anyone to stand in the machine working area. Accidental operation of the upperstructure swing control or of an attachment control could cause an accident. Stop all operations until everyone has moved away.
- Before operating the dozer blade (if equipped) make sure that there is no one in the working area of the latter.
- Operate all controls gradually to ensure smooth machine operation.
- Whenever load handling operations are to be carried out, it is imperative to adhere strictly to the instructions given in this manual and local legislation.
- It is forbidden to use the machine to carry out tasks other than those for which it is intended. Never use the equipment for sweeping the ground to level out rubble or push objects (transversal stress on the attachment).
- Stop the engine and remove the ignition key when the machine is not in use, even for short periods of time.

- The working area of the end attachment that is mounted may interfere with the machine. Interference may be caused due to the type of end attachment or installation of parts such as a cab guard. Always maintain a safe margin of distance. (Be careful of tool swing or accidental operations.)
- To access or exit the operator's compartment, the left-hand control arm must be in the raised position. Never forget this basic requirement.
- Never leave the operator's compartment while the engine is running.
- To get in or out of the cab, it is imperative that the upperstructure frame is in line with the undercarriage.
- Dust, smoke or mist can reduce visibility and cause an accident. Reduce speed or come to a complete halt until visibility has improved.
- Never jump down from the machine. When alighting from the machine or the upperstructure, always face the machine and use the steps and access handles.
- In the event of an operating problem or failure, move the machine to a safe place, lower the attachment to the ground, shut down the engine and remove the ignition key. Locate the problem, report it if necessary and take the necessary steps to warn others not to attempt to operate the machine.
- Before tilting the seat back forward, it is mandatory to raise the armrests to avoid any accidental operation of the control levers.
- Never turn the key of the battery master switch in "O" (Off) position when engine is running, the electrical systems can be damaged.
- When the engine is stopped, always wait three minutes minimum before to place the key of the battery master switch in "O" (Off) position, otherwise the program of the machine controllers will not exit successfully.

Preventing risks caused by vibrations

The machine's vibration affects the comfort and in some cases the health and safety of the operator. To reduce vibration risks to a minimum:

1. Make sure that the machine, the equipment and the tool are suitable for the work to be carried out.
2. Make sure that the machine is in good condition and that servicing intervals are complied with.
3. Check the track tension adjustment and the play in equipment linkages.
4. Make sure that the operator's seat and its adjustment controls are in good condition and then adjust the seat to suit the operator's size and weight. The operator's

seat complies with the ISO 7096, 2000 standard, EM 6 class.

During work:

1. Operate all controls gradually to ensure smooth machine operation.
2. Modify the machine's operation to suit the working conditions.
3. During travel, adjust the machine's speed, reducing it if necessary.
4. Make sure that the machine's operating radius is in good condition, and free of obstacles and holes.

Quick coupler (optional)

- Never place the control switch in the unlocked position when the machine is working.
- Each time a bucket is installed on the quick coupler, close the bucket and raise the attachment so as to be able to make a visual check that the bucket pin is correctly engaged in the latching hook.
- The quick coupler modifies the working range of the machine. In certain attachment positions the tool may foul the machine. Always leave a safety distance.
- Never carry out load handling using the front or rear anchoring points used to install the tool on the quick coupler.
- Never put your hands inside the quick coupler and never attempt to adjust or repair the quick coupler if the engine is running.

Parking the machine

When parking the machine, proceed as follows:

1. Position the machine on flat, level ground, away from soft ground, excavations or poorly shored cavities.
2. Place the upperstructure and the attachment in line with the undercarriage, retract the attachment and dig the bucket into the ground.
3. Lower the dozer blade (if equipped) until it rests on the ground.
4. Place the gate lock lever in central position before leaving the operator's compartment.
5. Stop the engine and remove the ignition key.
6. Lock the cab door.

7. Make sure that the hoods and doors are properly latched.
8. Check that no part of the machine is encroaching on the highway. If this cannot be avoided, install the necessary regulation signaling equipment.

Maintenance and adjustments

- Do not try to service this machine unless you have first read and perfectly understood the safety messages and instructions featuring in this manual.
 - When carrying out service work always wear suitable dress. Avoid loose-fitting clothing.
 - Release pressure completely in the hydraulic system before disconnecting the hydraulic piping. Hydraulic oil escaping under pressure can cause serious injury.
 - Before doing maintenance work on the machine, shut down the engine and allow it to cool down. Otherwise, you could be burned.
 - Before commencing any work on the machine, place a "Do not operate" tag on the right-hand control arm.
 - Always wear eye protection when using a tool that might project metal particles. Use a hammer with a soft face, such as copper, for installing pins.
 - Badly carried out maintenance or adjustments can cause serious injuries. If you do not understand a servicing or adjustment procedure, consult your CASE CONSTRUCTION Dealer.
 - If the attachment is raised or if the machine moves without an operator, serious injury can result. Before carrying out maintenance on this machine, proceed as follows:
Park the machine on flat, level ground.
Lower the attachment until it is resting on the ground.
Lower the dozer blade (if equipped) until it rests on the ground.
Stop the engine and remove the ignition key.
Lock the tracks to prevent any machine movement.
 - Any unauthorized modifications made to this machine can cause serious injury. Do not undertake any modifications without first consulting your CASE CONSTRUCTION Dealer. Any modifications made must be in conformity with the technical specifications of the machine and any current safety legislation requirements.
 - Certain components of the machine are subject to type approval. When replacing such components, it is mandatory to make sure that they conform to regulations. For safety's sake, use genuine CASE CONSTRUCTION parts.
 - Pressurized hydraulic fluid or grease which penetrates the skin can cause serious injury. Take the necessary safety precautions (safety clothing and protection for face and hands) to avoid such risks. Also, before using these products, read the manufacturer's instructions concerning their use. If hydraulic fluid penetrates the skin, call a doctor immediately.
 - Coolant solution is toxic.
- Avoid contact with skin, eyes and clothing.
Antidote:
External: rinse thoroughly with water and remove soiled clothes.
Internal: do not induce vomiting. Rinse the mouth out with water. Seek medical advice.
Eyes: rinse thoroughly with water and seek medical advice.
- The pressure in the track tension cylinders is high. Follow the procedure described in this manual carefully for increasing or reducing track tension.
 - When carrying out a welding operation on the undercarriage or upperstructure carriage as authorized by the manufacturer and in accordance with his instructions, disconnect the batteries, disconnect the alternator B+ and D+ terminal wires and connect the welding apparatus earth cable to the component on which the welding operation is to be performed. Never connect the welding apparatus to the undercarriage when welding on the upperstructure (or vice-versa). Never connect the welding apparatus earth to a component of the hydraulic system.
 - When using compressed air, take the necessary precautions to protect your face.
 - Clean the machine regularly. Accumulations of grease, dirt and debris can cause injuries or damage the machine.
 - Periodically inspect the fastening of the main components, as part of the machine maintenance programme: counterweight, turntable bearing and operator's compartment. In the event of problems, consult your CASE CONSTRUCTION Dealer.
 - If the accumulator is not functioning correctly, consult your CASE CONSTRUCTION Dealer. Never try to carry out any servicing operation on the accumulator. If this instruction is not followed serious injury can result.
 - The accumulator is charged with nitrogen under high pressure. Do not weld or allow flames to come near to the accumulator.
 - There is high pressure fuel in the feed pipe when the engine is running and immediately after it has been shut down. Wait for 2 minutes after engine shut down before you do any maintenance or inspections to allow the pressure to drop in the pipe.
 - High-voltage is charged to the controller and/or to the injector while the engine is running and immediately after it has been shut down.
Do not touch the controller or the injector.
If it is necessary to touch them for maintenance purposes, consult your CASE CONSTRUCTION Dealer.

⚠ Using an Implement other than a bucket ⚠

- When using a special implement (hydraulic breaker, cutter crusher etc.), refer to the operator's manual provided with the implement.

⚠ Implement operation and maintenance ⚠

- For the implement operation and maintenance, refer to the operator's manual provided with the implement.

⚠ Safety area ⚠

The safety area is the space necessary for the machine to operate at the maximum range of the tool and at full swing **360° plus 2 m (6.56 ft)**.

(1) Working area.

(2) Safety area.

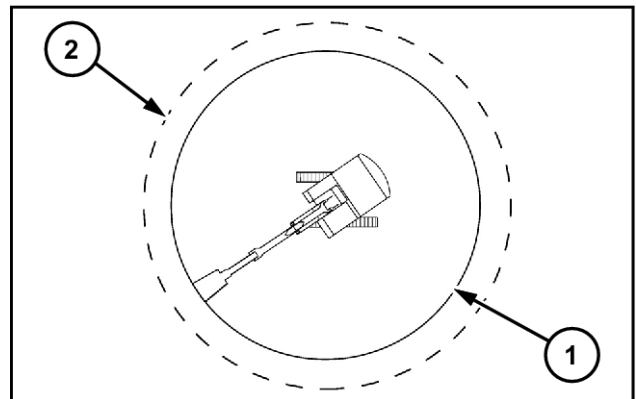

SMIL13CEX2517AB 1

Ecology and the environment

Soil, air, and water quality is important for all industries and life in general. When legislation does not yet rule the treatment of some of the substances that advanced technology requires, sound judgment should govern the use and disposal of products of a chemical and petrochemical nature.

Familiarize yourself with the relative legislation applicable to your country, and make sure that you understand this legislation. Where no legislation exists, obtain information from suppliers of oils, filters, batteries, fuels, anti-freeze, cleaning agents, etc., with regard to the effect of these substances on man and nature and how to safely store, use, and dispose of these substances. Your CASE CONSTRUCTION dealer can also provide assistance.

Helpful hints

- Avoid the use of cans or other inappropriate pressurized fuel delivery systems to fill tanks. Such delivery systems may cause considerable spillage.
- In general, avoid skin contact with all fuels, oils, acids, solvents, etc. Most of these products contain substances that may be harmful to your health.
- Modern oils contain additives. Do not burn contaminated fuels and or waste oils in ordinary heating systems.
- Avoid spillage when you drain fluids such as used engine coolant mixtures, engine oil, hydraulic fluid, brake fluid, etc. Do not mix drained brake fluids or fuels with lubricants. Store all drained fluids safely until you can dispose of the fluids in a proper way that complies with all local legislation and available resources.
- Do not allow coolant mixtures to get into the soil. Collect and dispose of coolant mixtures properly.
- Do not open the air-conditioning system yourself. It contains gases that should not be released into the atmosphere. Your CASE CONSTRUCTION dealer or air-conditioning specialist has a special extractor for this purpose and can recharge the system properly.
- Repair any leaks or defects in the engine cooling system or hydraulic system immediately.
- Do not increase the pressure in a pressurized circuit as this may lead to a component failure.
- Protect hoses during welding. Penetrating weld splatter may burn a hole or weaken hoses, allowing the loss of oils, coolant, etc.

Battery recycling

Batteries and electric accumulators contain several substances that can have a harmful effect on the environment if the batteries are not properly recycled after use. Improper disposal of batteries can contaminate the soil, groundwater, and waterways. CASE CONSTRUCTION strongly recommends that you return all used batteries to a CASE CONSTRUCTION dealer, who will dispose of the used batteries or recycle the used batteries properly. In some countries, this is a legal requirement.



NHIL14GEN0038AA 1

Hand signals

When operating the machine, never attempt to carry out tasks calling for fine control or working in areas where visibility is poor or impaired without seeking the assistance of a signalman. Make perfectly sure that you and the signalman understand the signals to be used.

Start the engine



PDE0002ATBP1 1

Move away from me

Wave hands back and forth (palms outwards).



PDE0003TBP1 4

Shut down the engine

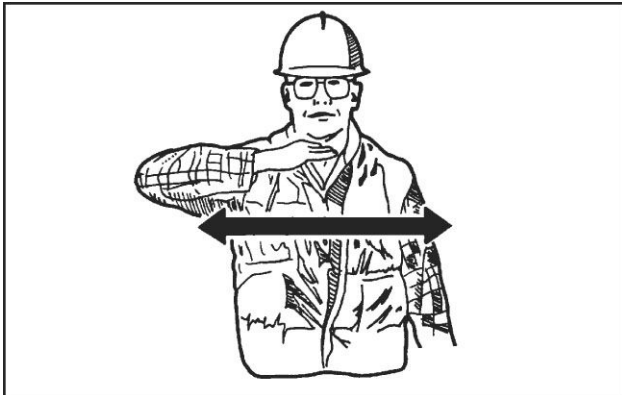

PDE0002TBP1 2

Go this far

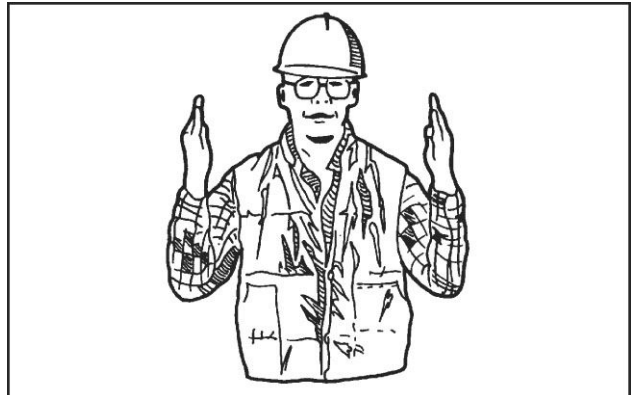

PDE0004ATBP1 5

Come to me

Wave hands back and forth (palms inwards).



PDE0003ATBP1 3

All stop and hold



PDE0004TBP1 6

Stop

Wave one hand back and forth.

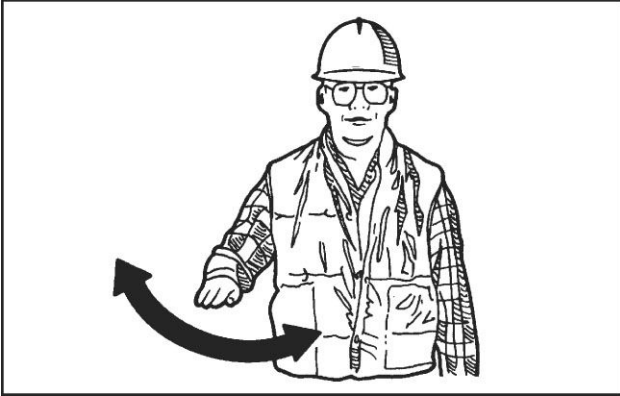

PDE0005ATBP1 7

Lower load or tool



PDE0006TBP1 10

Emergency stop

Wave hands back and forth.

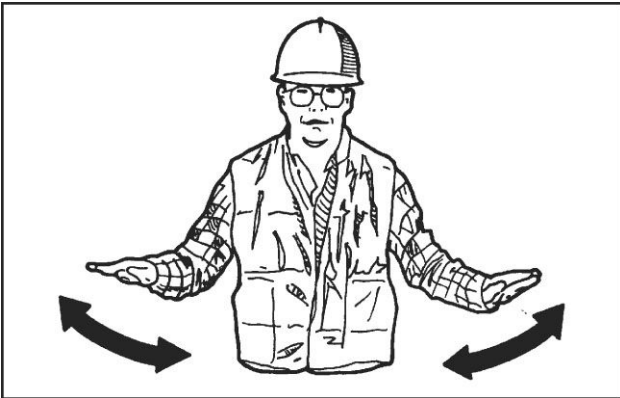

PDE0005TBP1 8

Slowly raise the load or tool

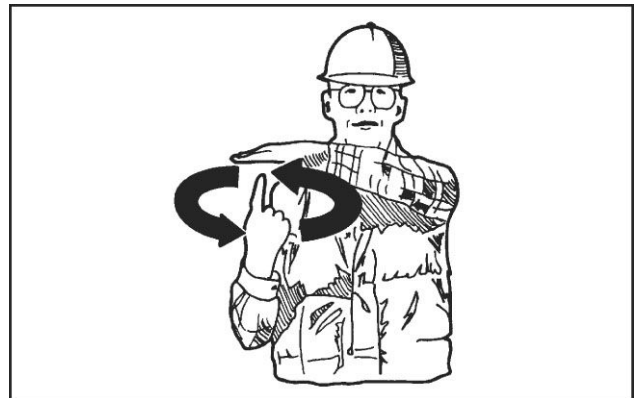

PDE0007ATBP1 11

Raise load or tool



PDE0006ATBP1 9

Slowly lower the load or tool



PDE0007TBP1 12

Turn machine left (swing load left)

To stop movement, stop moving hand and clench fist.

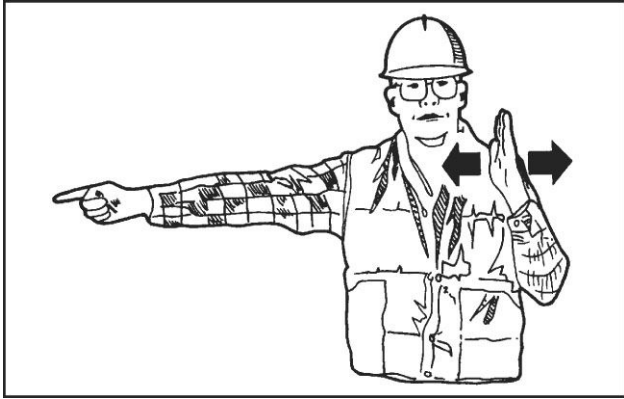

PDE0008ATBP1 13

Lower tool



PDE0009TBP1 16

Turn machine right (swing load right)

To stop movement, stop moving hand and clench fist.

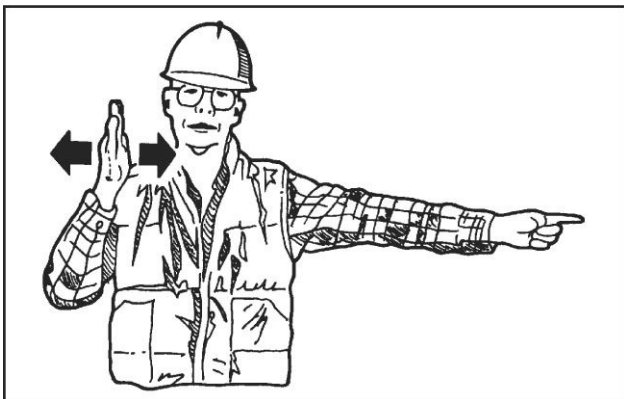

PDE0008TBP1 14

Lift boom

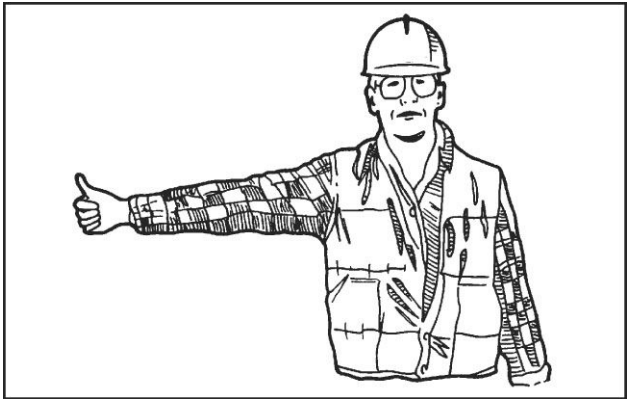

PDE0010ATBP1 17

Raise tool



PDE0009ATBP1 15

Lower boom



PDE0010TBP1 18

Retract arm



PDE0011ATBP1 19

Fill tool

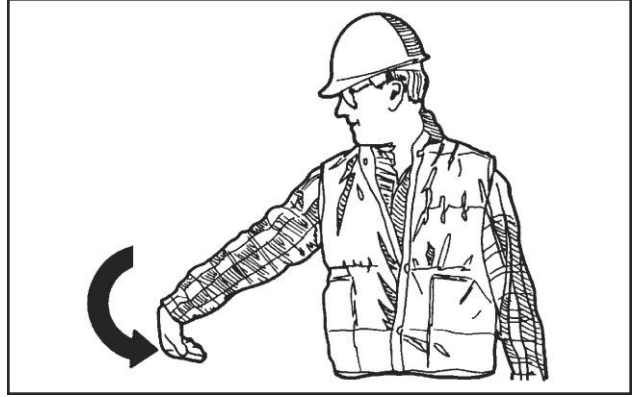

PDE0012ATBP1 21

Extend arm

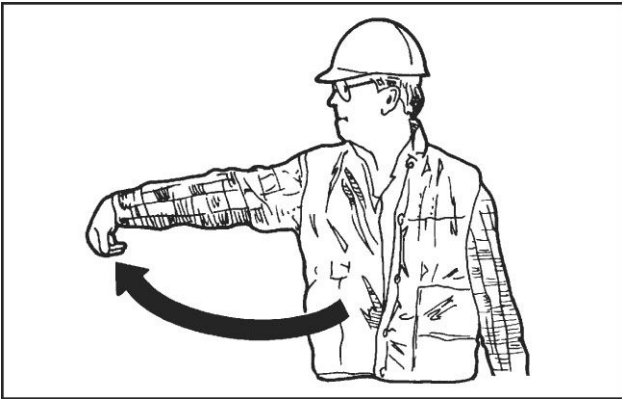

PDE0011TBP1 20

Empty tool

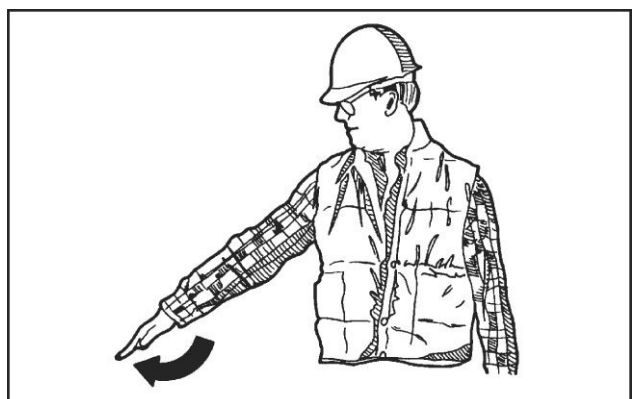

PDE0012TBP1 22

Safety signs

⚠ WARNING

Avoid injury!

Make sure decals are perfectly legible. Clean decals regularly. Replace all damaged, missing, painted over, or illegible decals. See your dealer for replacement decals. When replacing parts bearing decals, be sure to put new decals on each new part.

Failure to comply could result in death or serious injury.

W0229A

⚠ WARNING

Avoid injury!

An illegible or missing decal can have far-reaching consequences. Inspect decals daily.

Failure to comply could result in death or serious injury.

W0228A

The following safety signs are on your machine as a guide for your safety and for the safety of those working with you. Walk around the machine and note the content and the location of all safety signs before you operate your machine.

Keep all safety signs clean and legible. Clean safety signs with a soft cloth, water, and gentle detergent.

NOTICE: *do not use solvent, gasoline, or other harsh chemicals. Solvents, gasoline, and other harsh chemicals may damage or remove safety signs.*

Replace all safety signs that are damaged, missing, painted over, or illegible. If a safety sign is on a part you or your CASE CONSTRUCTION dealer replaces, make sure that you or your CASE CONSTRUCTION dealer install the safety sign on the new part. See your CASE CONSTRUCTION dealer for replacement safety signs.

Safety signs that display the "Read operator's manual" symbol direct you to the operator's manual for further information regarding maintenance, adjustments, or procedures for particular areas of the machine. When a safety sign displays this symbol, consult the appropriate page of the operator's manual.



Safety signs that display the "Read service manual" symbol direct you to the service manual. If you doubt your ability to perform service operations, contact your CASE CONSTRUCTION dealer.



Decal positions

When replacing a decal, make sure it is located as shown below.

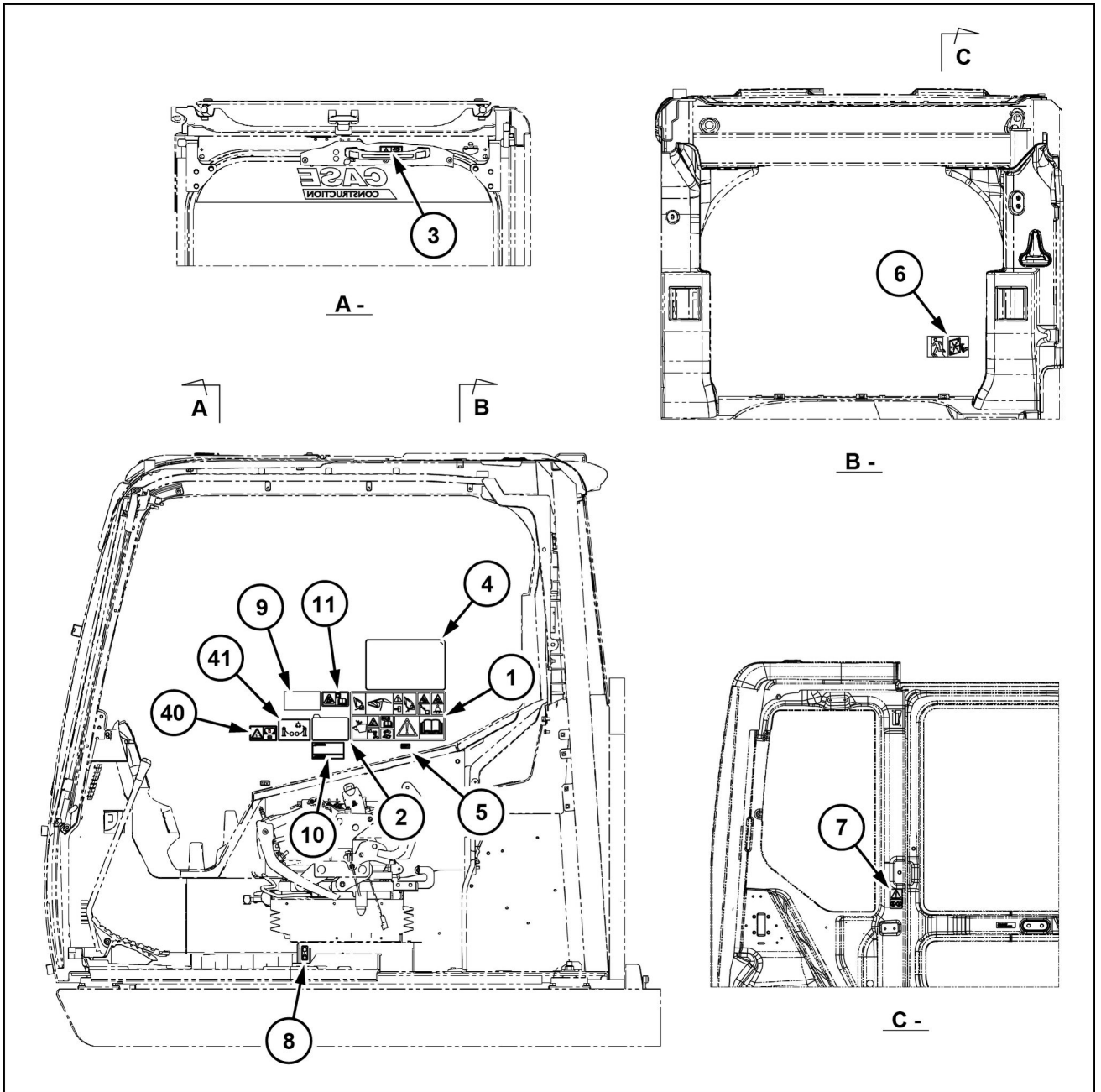

SML22CEX3953GA 1

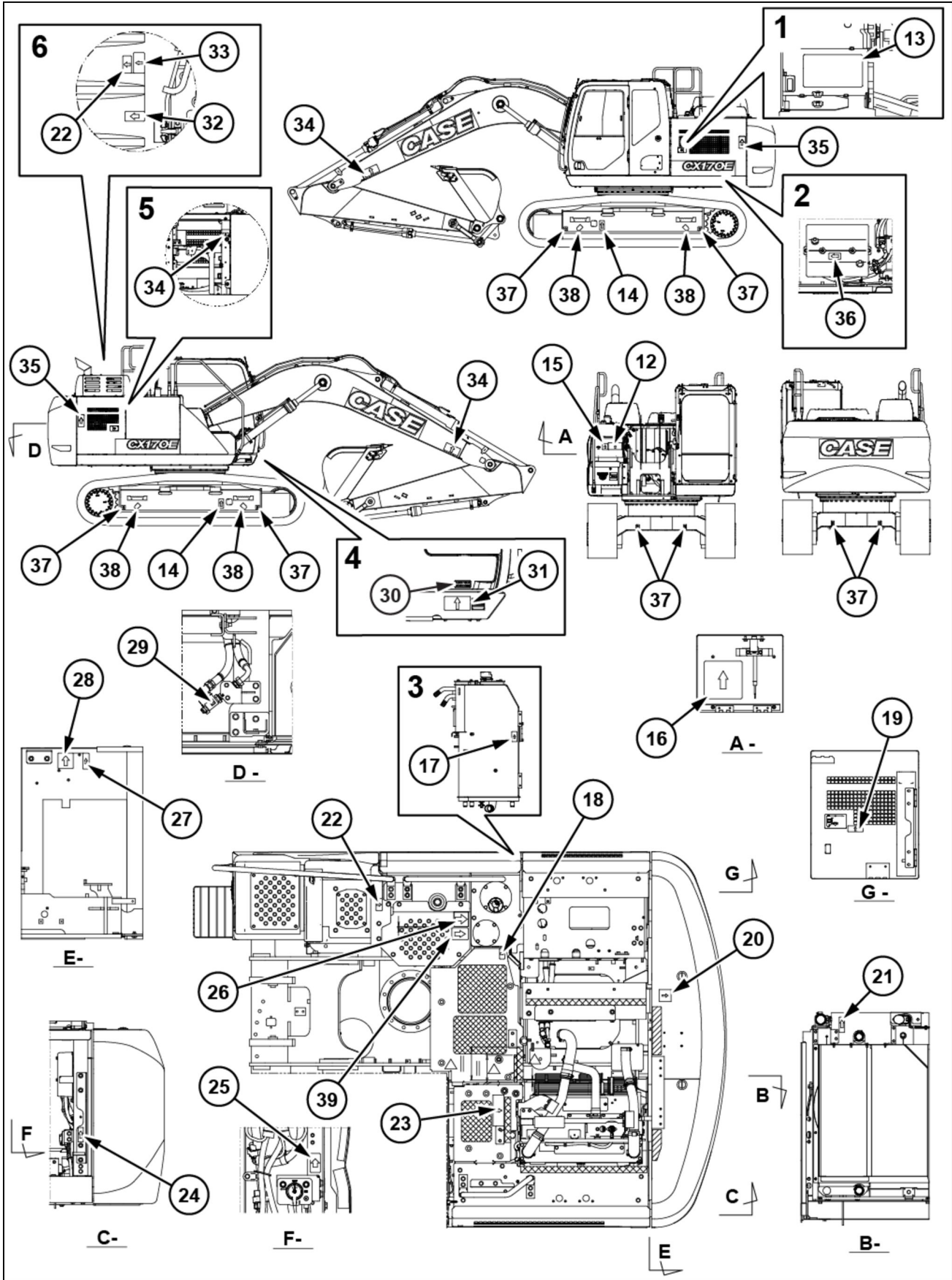

Decal placement diagrams

(1) Table of safety precautions

Part number: KHP39552

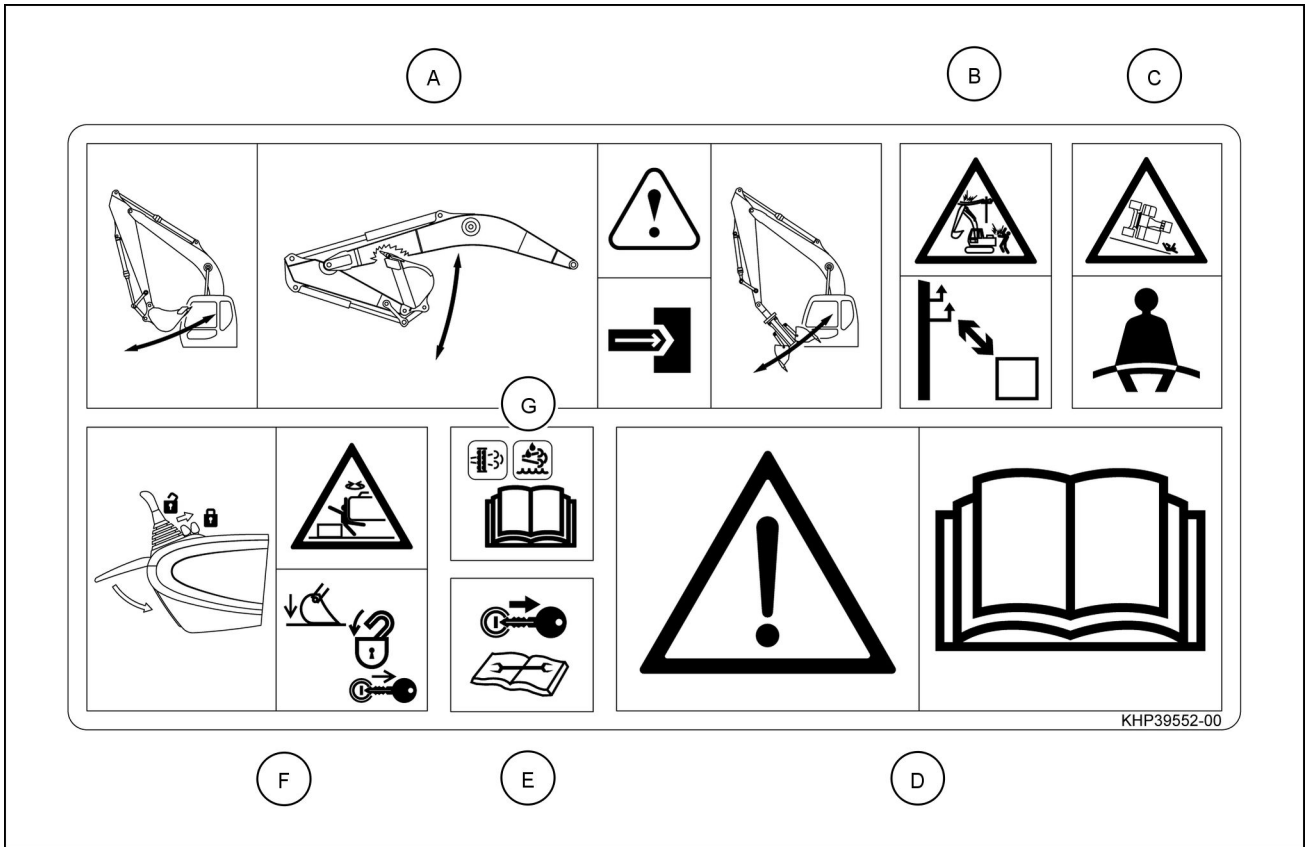

KHP39552-00 3

(1A) Interference with attachments

The end attachment used for machine operation (e.g. bucket, hydraulic breaker, clamshell..) may hit the cab and/or the boom depending upon the length of the arm, the size of the bucket or the installation of a quick coupler.

Always check the operating range of the machine with the specific attachment in use. Avoid abrupt operation in order to keep proper clearance between the attachment and the cab or boom or other significant parts of the machine.

Collisions between attachment and cab or boom or other significant parts of the machine can cause serious damages.

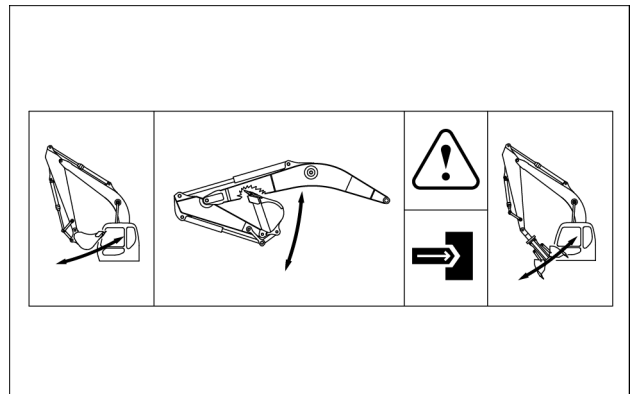

KHP35790_A 4

(1B) Danger electric line

When working near overhead high-voltage electric lines, there is a high risk of electric shocks.

Always keep minimum distances to the electric lines in order to avoid serious damages to the machine, and to avoid serious injuries to the bystanders.

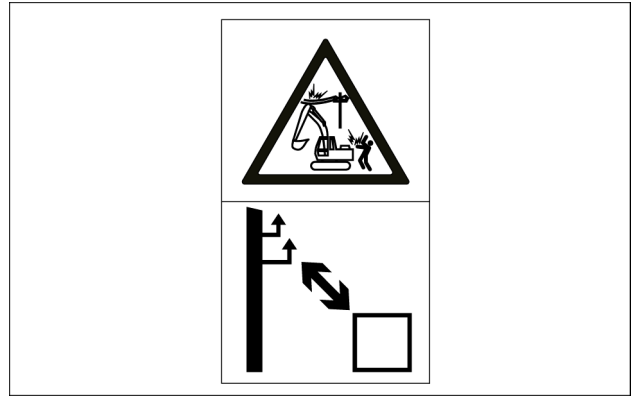

KHP35790_B 5

(1C) Seat belt

Always fasten the seat belt before starting machine operation.

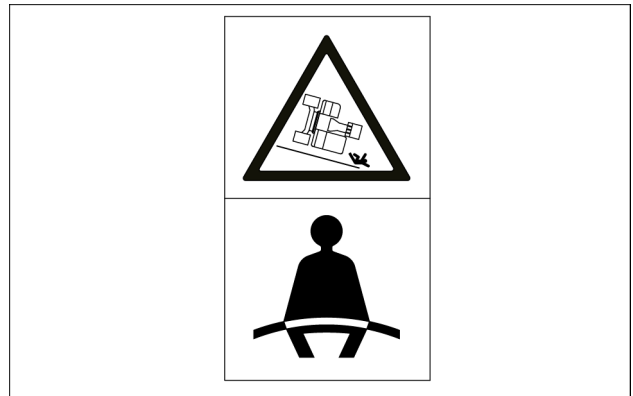

KHP35790_C 6

(1D) Operator's manual

Make sure to read the operator's manual to understand how operate the machine properly and safely.

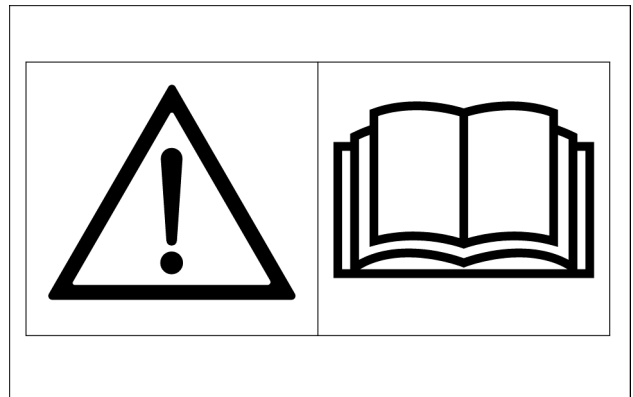

KHP35790_D 7

(1E) Maintenance or inspection

Always stop the engine and remove the starter key before any maintenance operation or inspection of the machine.

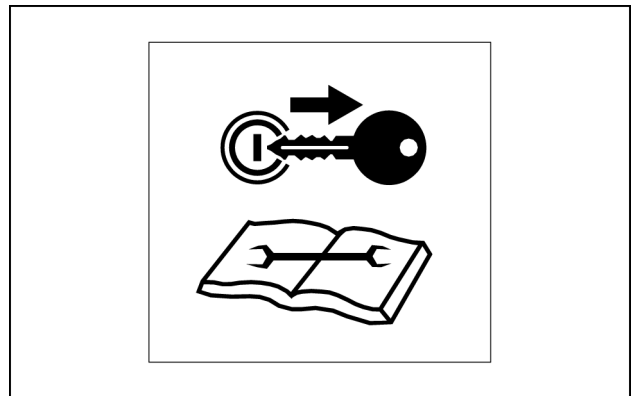

2ZZ45 8

(1F) Parking the machine

Before leaving the operator's compartment, always lower the bucket to the ground, place the gate lock lever in locked position, stop the engine and remove the starter key in order to prevent any unintended movement of the machine.

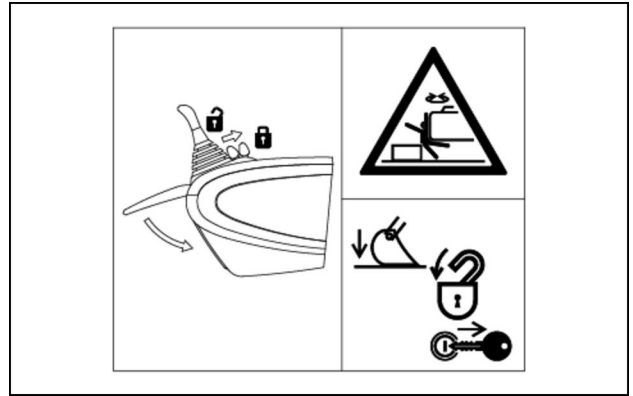

KHP36590_F 9

(1G) DEF/AdBlue® Icon, ATS Icon Display

This decal means that the operator must take appropriate measures according to the procedures stated in the operator's manual if these icons are displayed.

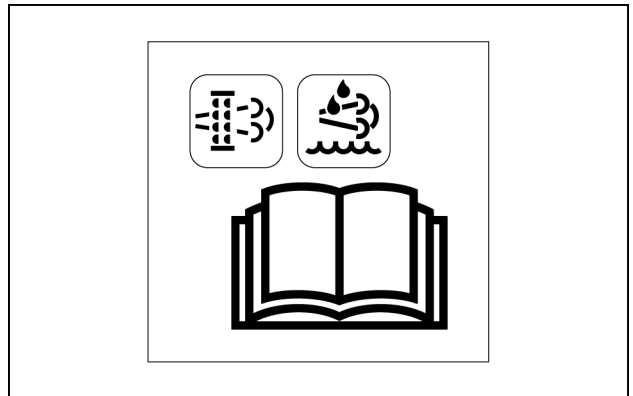

4ZZ45 10

(2) Functions of operation levers

Part number: KHP27560

Part number: KHP27000

Functions of the left control lever and the right control lever.

Always make sure to place the sheet that maps the operating controls to the side corresponding to the selected control pattern.

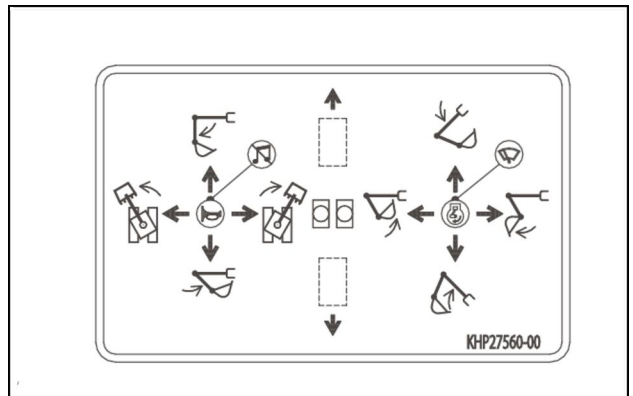

KHP27560 11

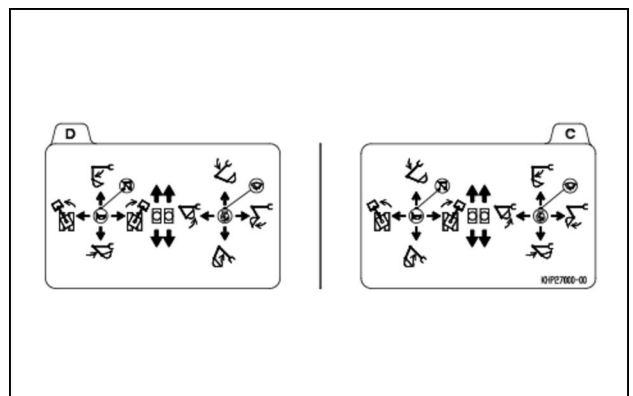

KHP27000 12

(3) Windshield locking

Part number: KHP35800

Always lock the windshield when it is set in open position.

Windshield not locked may fall down and can affect safe and proper operation of the machine, and can even cause injuries.

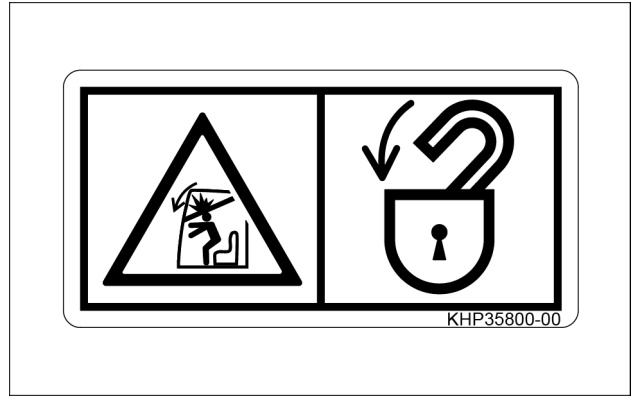

KHP35800 13

(4) Rated lift capacity table

Always make sure to lift loads not exceeding the maximum values prescribed by the rated lift capacity table.

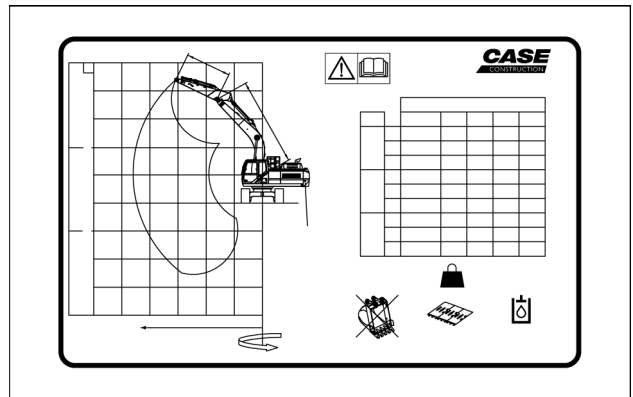

KBP23210 14

(5) Cigarette lighter socket 24 V

Part number: KHP11590

24 V electric socket. Connect only **24 V** devices to this socket.

Connecting devices functioning at different voltage can cause damages to the device itself and to the electrical system of the machine.

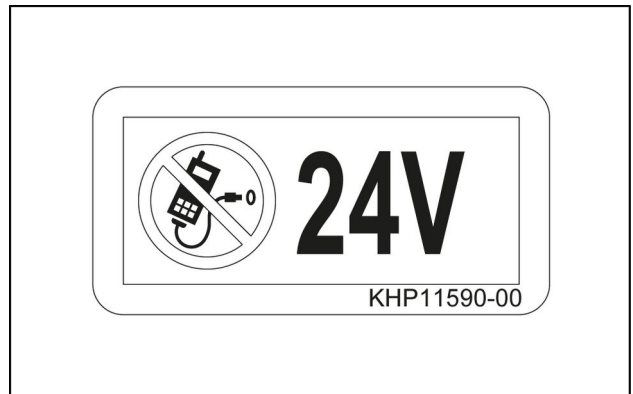

SMIL14CEX1620AB 15

(6) Emergency exit

Part number: KHP1247

In case of emergency, use the emergency hammer to break the rear window and get out from the machine.

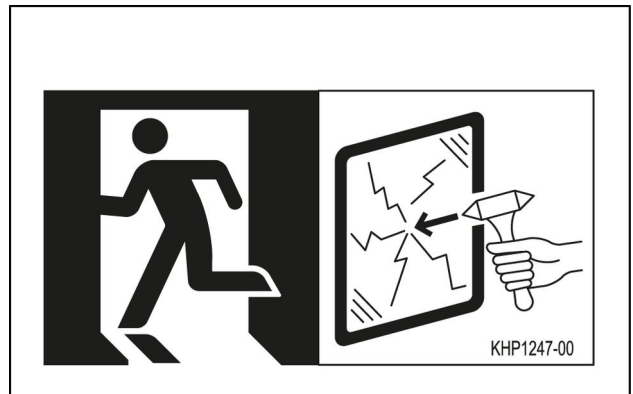

SMIL14CEX1621AB 16

(7) Handling precautions in operation compartment

Part number: KHP35810

Welding or modification to the cab structure is strictly forbidden.

Welding or modification to the cab structure affects cab's strength, and compromises operator's protection.



KHP35810 17

(8) Emergency stop switch operation

Part number: KHP34750

Press the top side of the switch only if an emergency stop of the engine is necessary.

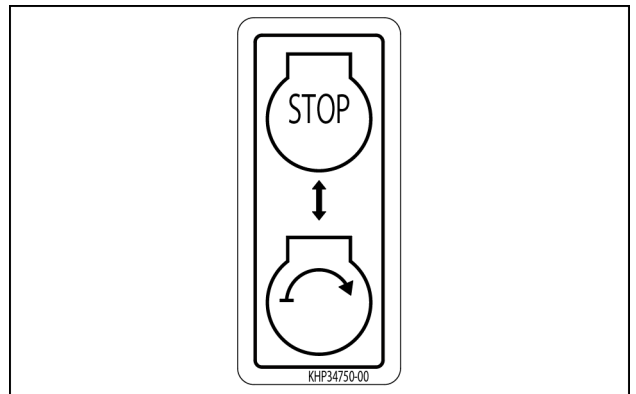

KHP34750 18

(9) Precautions for operation pattern

Part number: KHP18200

Before starting machine operation, check that the operating pattern shown on the control pattern card is consistent with the operating pattern of control levers.

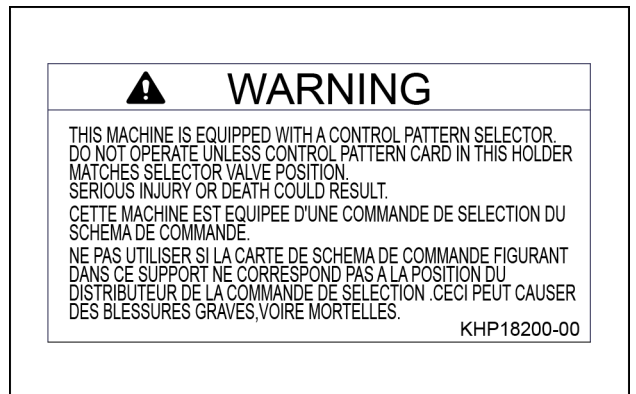

KHP18200 19

(10) CALIFORNIA PROPOSITION 65 warning

Part number: KHP38510

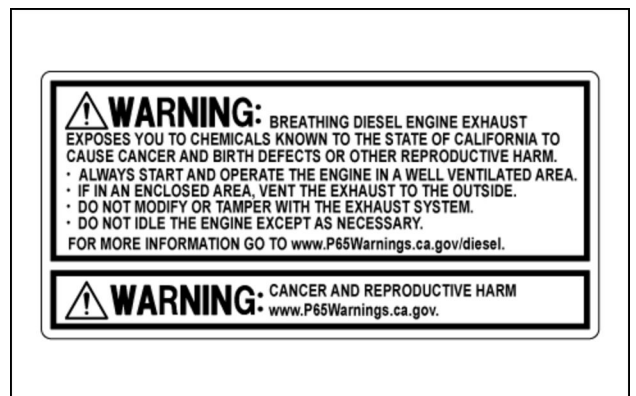

KHP38510 20

(11) Cautions for operation during swing free

Part number: KHP18370

The free swing function delays the swing stop.

Operating on a slope with the free swing function active is dangerous. Make sure to read the Operator's manual to understand how operate the free swing function properly and safely.

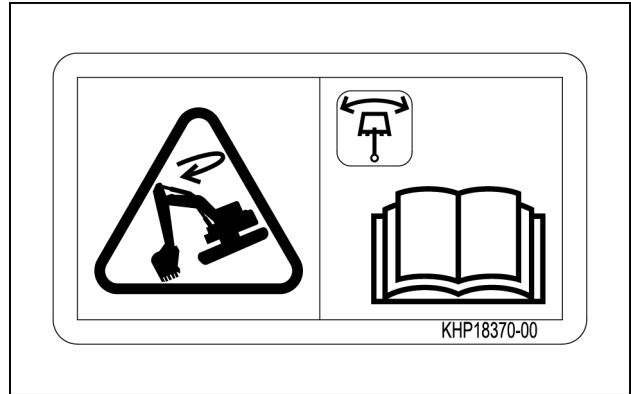

KHP18370 21

(12) Electric shock

Part number: KHP35910

When working near overhead high-voltage electric lines, there is a high risk of electric shocks.

Always keep minimum distances to the electric lines in order to avoid serious damages to the machine, and to avoid serious injuries to the bystanders.

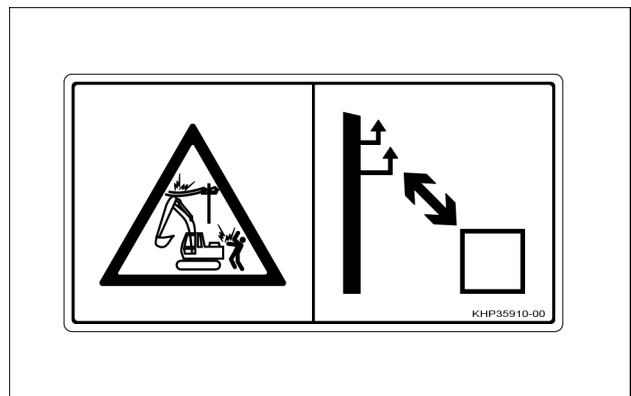

KHP35910 22

(13) Precautions for operation pattern

Part number: KHP34880

Before starting machine operation, check that the operating pattern shown on the control pattern card is consistent with the operating pattern of control levers.

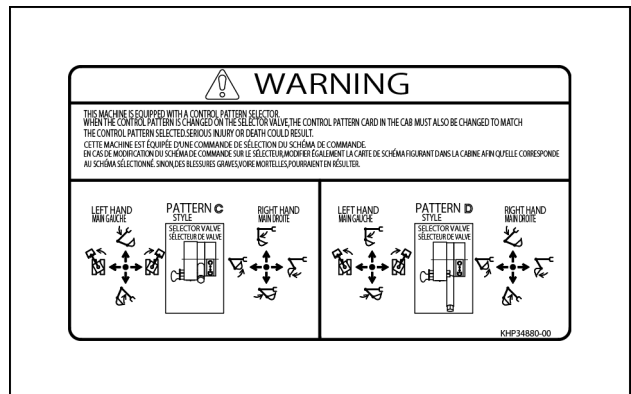

KHP34880 23

(14) Check valve

Part number: KHP35930

Track tensioning cylinder contains pressurized fluid.

During maintenance of the track tensioning cylinder, fluid may spray out from the check valve on the tensioning cylinder and can cause serious injuries.

Always make sure to read operator's manual to understand proper practices and precautions to be tackled for maintenance of the track tensioning system.



KHP35930 24

(15) DEF/AdBLUE® tank

Part number: KHP35831

Do not fill the **DEF/AdBLUE®** tank with diesel fuel, water or any fluid other than **DEF/AdBLUE®**.

Using any other kind of fluid will cause serious damages to the machine.

Make sure to read operator's manual to understand proper procedures to be used for storage and usage of **DEF/AdBLUE®**.



KHP35831 25

(16) Service table

Part number: KLP13760

Reference chart indicating proper timing for machine maintenance.

Make sure to read operator's manual to understand proper procedures for servicing the machine.

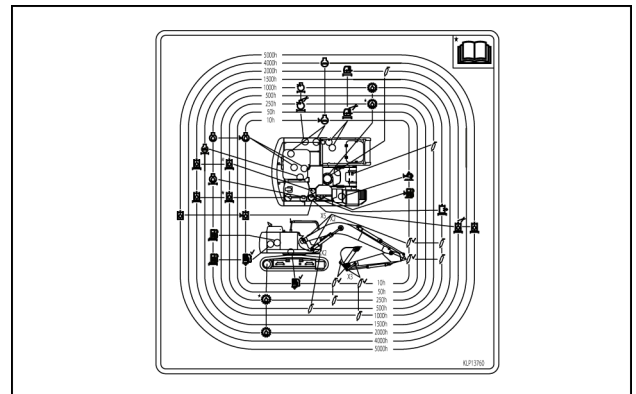

KLP13760 26

(17) Hydraulic oil level inspection

Part number: KHP39690

This decal shows information on hydraulic oil inspection.

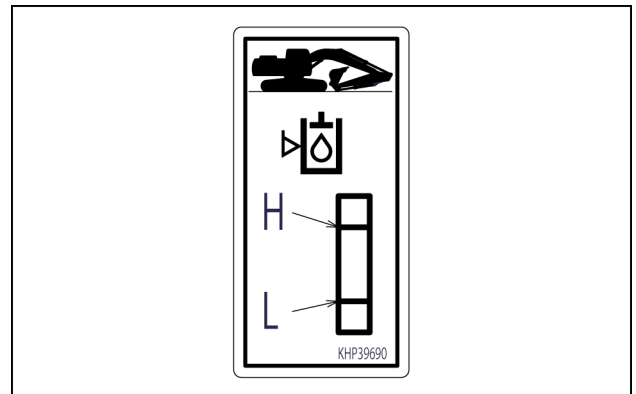

KHP39690 27

(18) Muffler

Part number: KHP36430

Do not touch the muffler right after engine stop.

Muffler surface is hot and touching it can cause serious injuries.

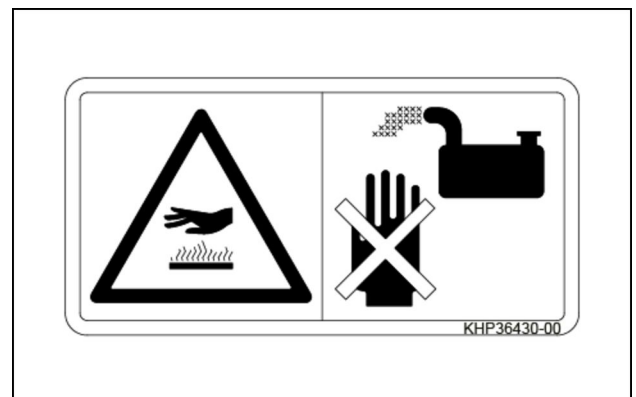

KHP36430 28

(19) Fuel filter replacement

Part number: KHP39460

Always perform the fuel filter replacement after reading the operator's manual.

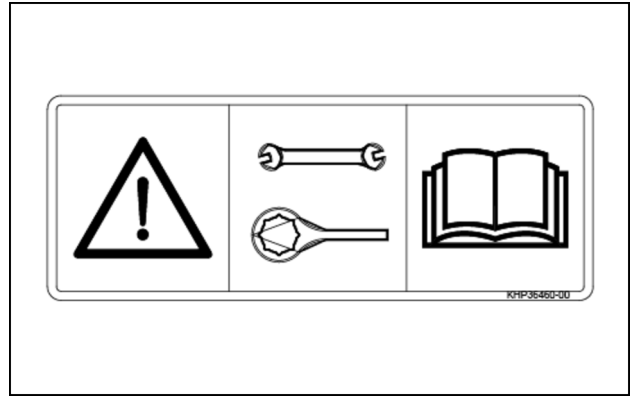

KHP39460 29

(20) Camera wiring precautions

Part number: KHP35920

Always disconnect the wiring of the cameras before removal of the counterweight.

Make sure to read operator's manual to understand proper procedures to be used for removal of the counterweight.

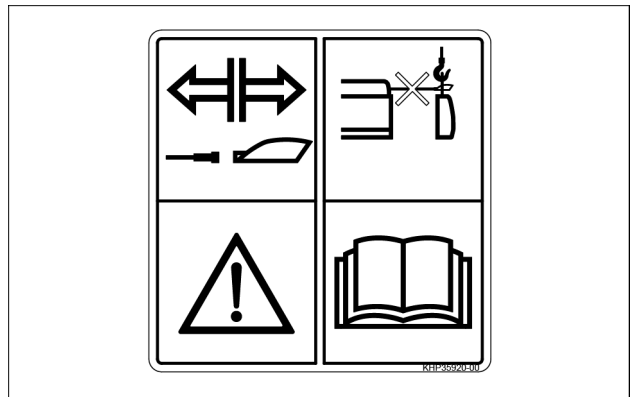

KHP35920 30

(21) Radiator

Part number: KHP35860

Do not loosen or open the radiator cap when coolant is hot and under pressure, it can cause serious injuries.

Cool down the engine before opening the radiator cap, then loosen the radiator cap slowly to relieve pressure in the coolant circuit.

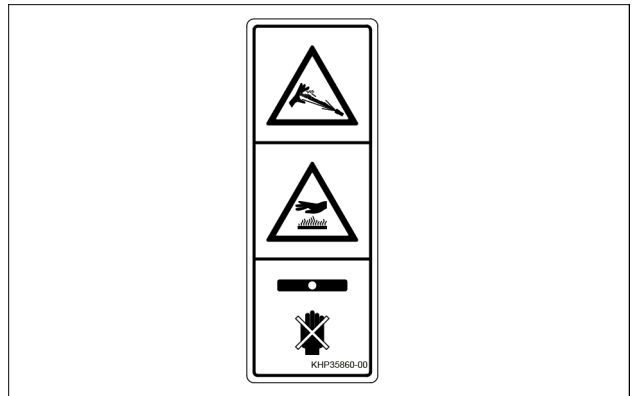

KHP35860 31

(22) Engine hood

Part number: KHP35870

Do not step over platforms that are not guarded by handrails in order to avoid the risk of falling.

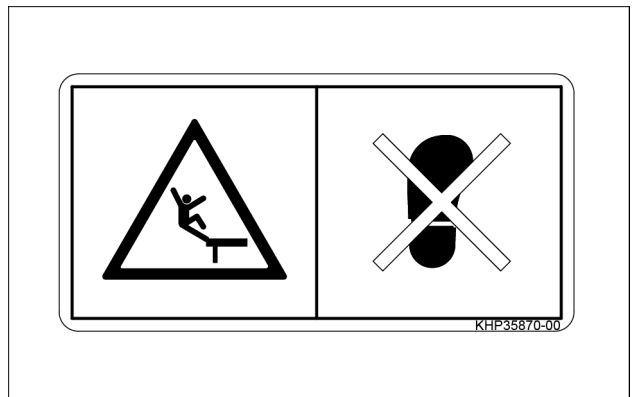

KHP35870 32

(23) Engine operation general decal

Part number: KHP36610

Always stop and cool down the engine before making any maintenance operation in the engine compartment.

Do not step on the engine as this can cause serious damages to the engine components and serious injuries to the operator.

When the engine is running, keep away from the engine cooling fan, from the fan belt and from the other rotating parts of the mechanical fan drive system. Rotating parts can cause serious injuries.

Make sure to read operator's manual to understand proper precautions when working into the engine compartment.

This decal warns the operator not to accidentally touch the cover of line that connects the intercooler and the turbocharger during the engine operation or right after the engine stop. The hot surface may cause a burn. The slippery surface may cause an unstable condition.

(24) Handling precautions for battery disconnect switch

Part number: KHP22050

Make sure to read operator's manual to understand proper procedures for usage of the battery disconnect switch.

(25) Precautions for battery disconnect switch

Part number: KHP39960

Never turn the battery disconnect switch to OFF position when the indicator lamp is lit.

Make sure to read the operator's manual to understand warning signs and icons related to the functioning of the battery disconnect switch.

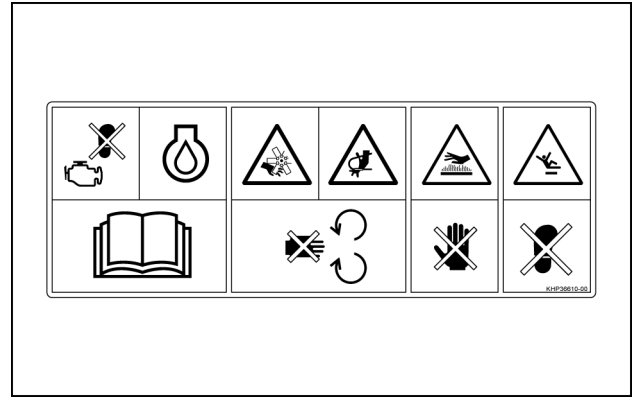

KHP36610 33

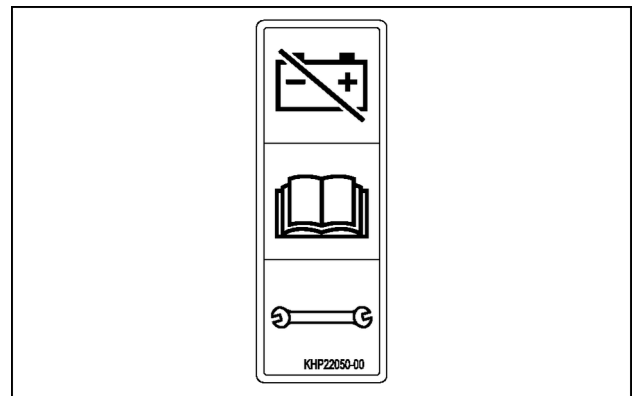

SMIL14CEX1645AB 34

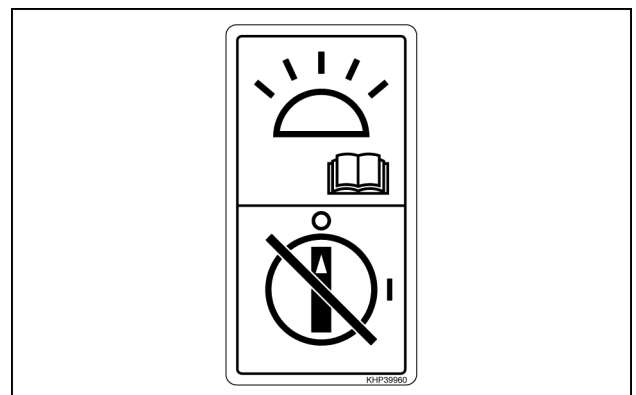

KHP39960 35

(26) Fuel tank

Part number: KHP35840

Do not perform welding and avoid any operation generating sparks close to the fuel tank.

Fuel is flammable and flames can cause serious injuries.

Do not fill the fuel tank with water, **DEF/AdBLUE®** or any fluid other than Ultra Low Sulfur diesel fuel.

Using any other kind of fuel will cause serious damages to the machine.

Make sure to read operator's manual to understand proper procedures to be used for storage and usage of Ultra Low Sulfur diesel fuel.

(27) Global warming potential decal

Part number: KHP42250

Greenhouse gas: HFC-134a

Quantity (A/C system charge): **0.85 kg (1.9 lb)**

Global Warming Potential (GWP): 1.22 Ton

Service, repair, or recharging must be performed only by trained service technician. Always contact your local authorized dealer. Failure to comply could result in death or serious injury.

(28) Common rail high pressure decal and starting the engine

Part number: KHP25860

Common rail injection system contains fuel under extreme pressure that can cause fatal injuries. Do not open the common rail pump, or loosen the common rail high pressure lines, or touch any other component of the common rail injection system.

Consult the CASE CONSTRUCTION dealer for service.

Do not try to start the engine by auxiliary tools. Machine may start to move suddenly and unintendedly causing serious injuries to the operator and to the bystanders.

(29) Engine oil sampling port

Part number: KHP25990

This decal shows the position of the engine oil sampling port.

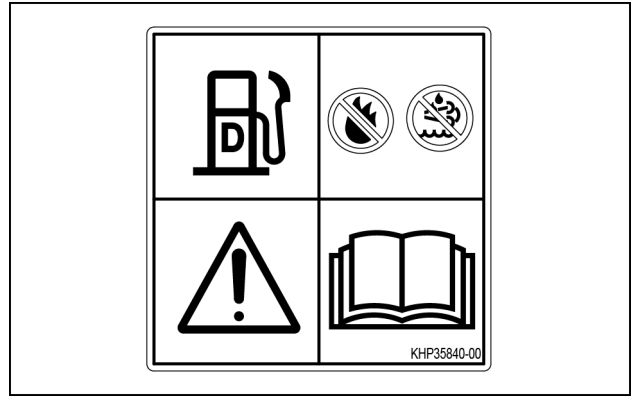

KHP35840 36

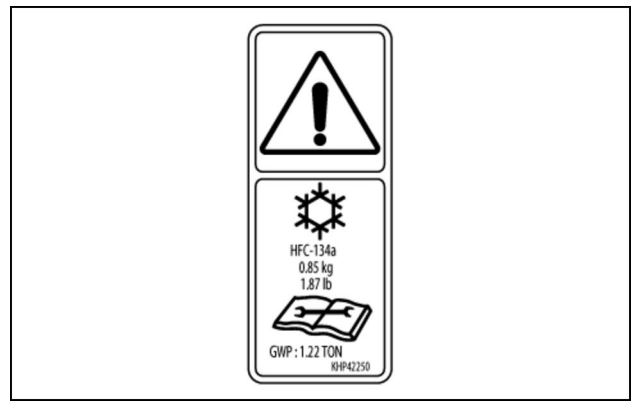

KHP42250 37



KHP25860 38

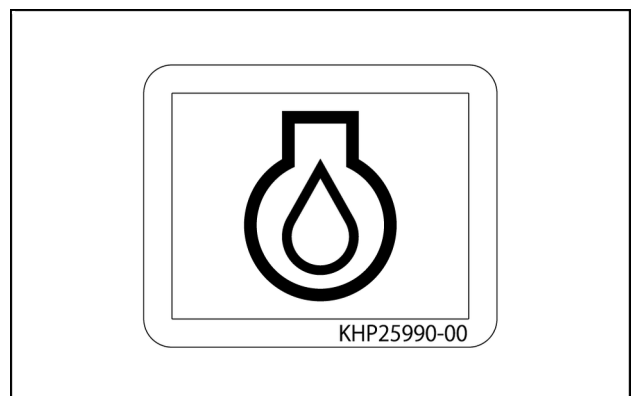

KHP25990 39

(30) Innovation, science and economic development

Part number: KHP34690

ICES-002 Compliance Label

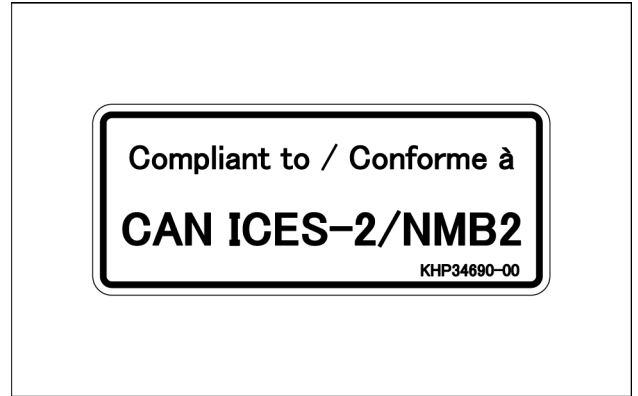

SMIL22CEX1298AA 40

(31) Instruction decal for restraint and lifting

Part number: KHP25960

Reference sketches mapping the layout of devices for transport and lifting of the machine.

Make sure to read operator's manual to understand proper procedures for transport and lifting of the machine.

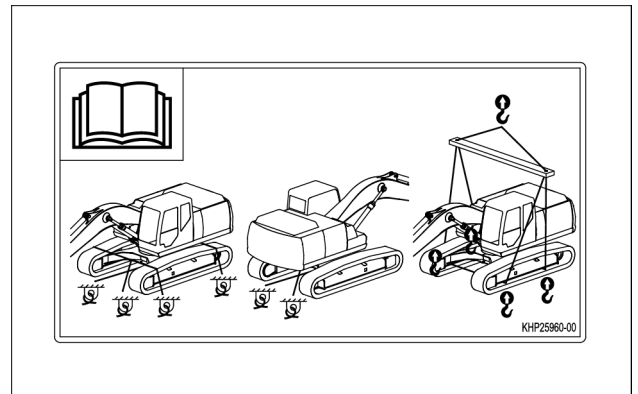

KHP25960 41

(32) Engine hood

Part number: KHP35890

Always lock the engine hood when it is set in open position for maintenance operations.

Engine hood not locked may fall down causing serious injuries.

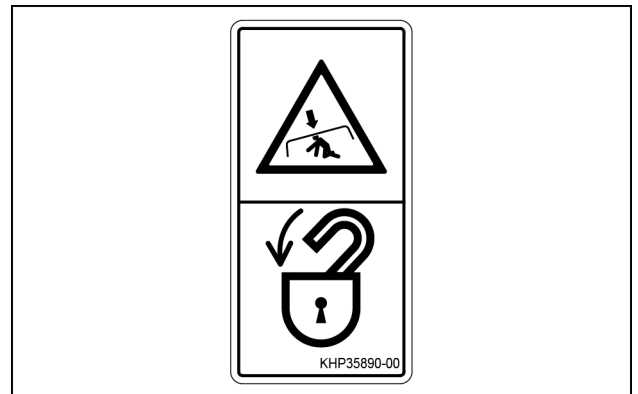

KHP35890 42

(33) Fan

Part number: KHP36410

When the engine is running, keep away from the engine cooling fan, from the fan belt and from the other rotating parts of the mechanical fan drive system.

The engine cooling fan and other rotating parts can cause serious injuries.

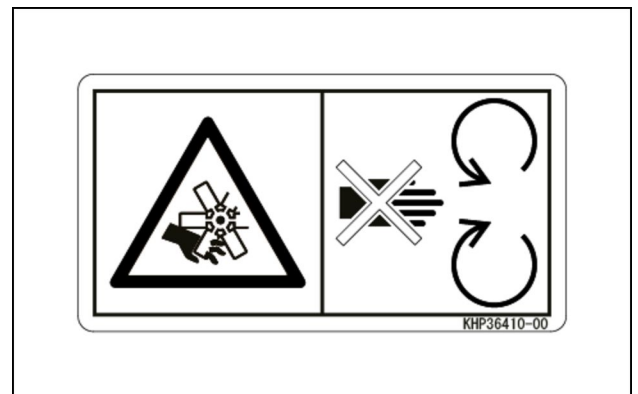

KHP36410 43

(34) Keep out of work range of attachment

Part number: KHP35940

Always make sure to keep the working range of the machine front equipment clear from obstacles and from bystanders.

Always sound the horn before start operating the machine.

The machine front equipment may hit or crush the bystanders causing serious injuries.

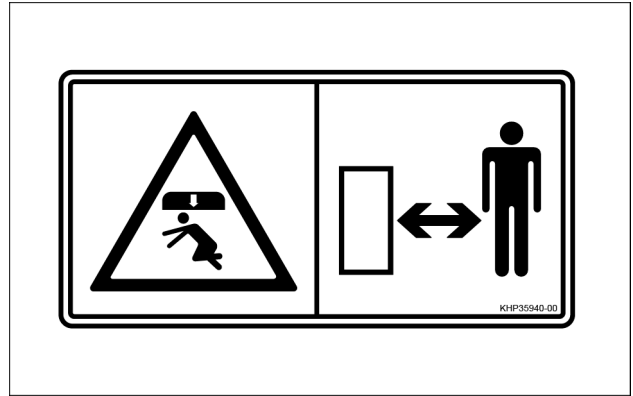

KHP35940 44

(35) Keep out of work range of upper structure

Part number: KHP35820

Always make sure to keep the working range of the machine upper structure clear from obstacles and from bystanders.

Always sound the horn before start operating the machine.

The machine upper structure may hit or crush the bystanders causing serious injuries.



KHP35820 45

(36) Batteries

Part number: KHP35900

Prevent battery explosion by keeping sparks, open flames and cigarettes away from the batteries.

Always make sure to read operator's manual to understand proper practices and precautions to be tackled for maintenance of batteries.

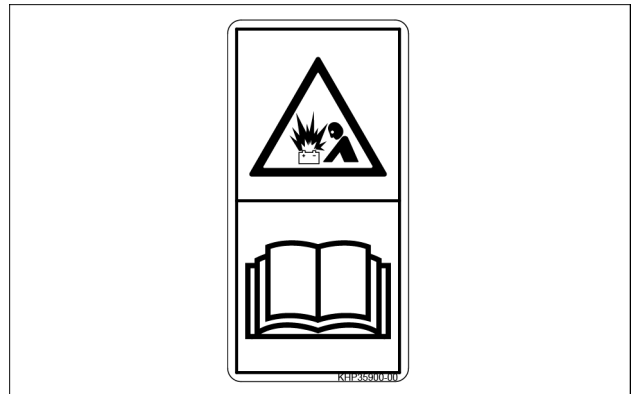

KHP35900 46

(37) Lashing point decal

Part number: KHP15201

Point on machine structure for securing the machine during transport.

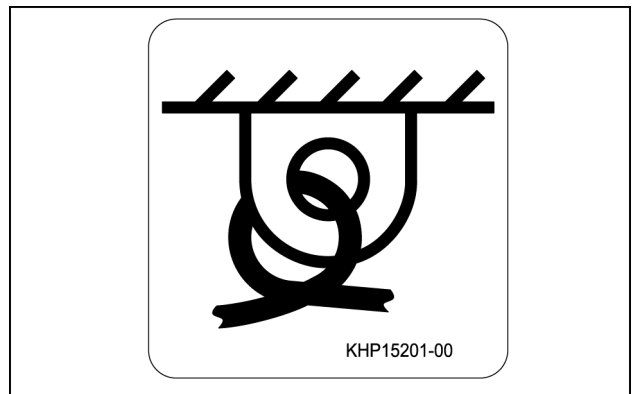

SMIL15CEX0447AA 47

(38) Lifting location

Part number: KHP19380

Machine area where the lifting devices should be routed.

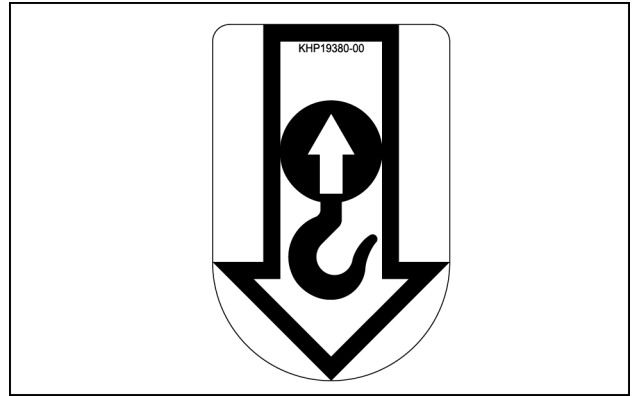

SMIL15CEX0450AA 48

(39) Fuel used

Part number: KHP18120

Use only Ultra Low Sulfur diesel fuel. Usage of different kinds of fuel will cause serious damages to the machine.

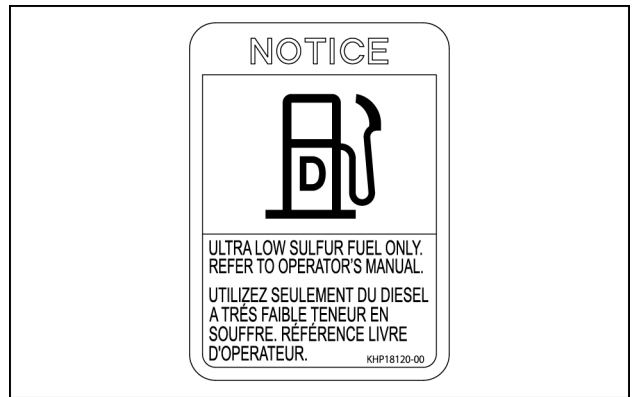

KHP18120 49

(40) Blind spot of Field View Monitor (optional)

Part number: KHP33700

The Field View Monitor system does not ensure visibility on the closest area around the machine.

Make sure to read the operator's manual to understand proper practices and precautions to be tackled for machine operation with the Field View Monitor system (Optional).

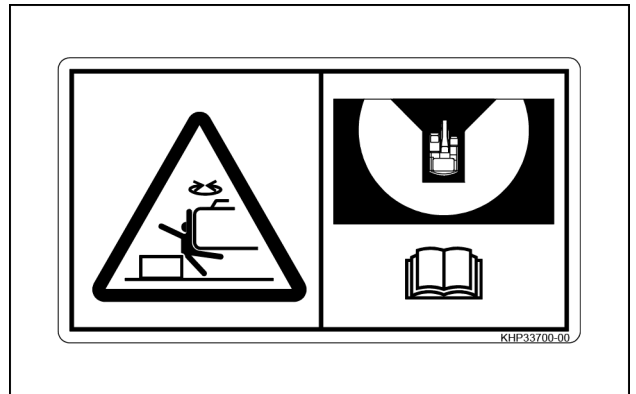

KHP33700 50

(41A) Functions of operation levers (optional)

Part number: KHP27030

Functions of the right control lever.

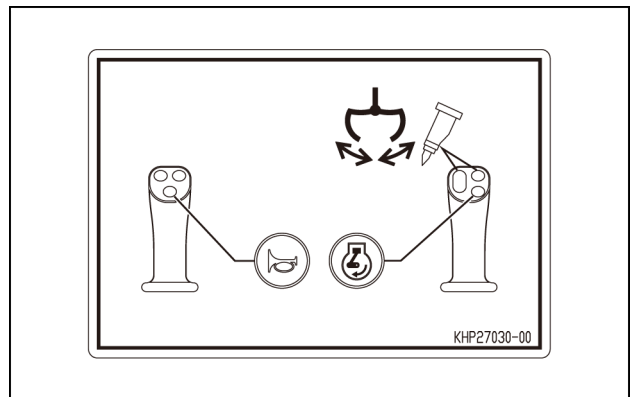

KHP27030 51

(41B) Functions of operation levers (optional)

Part number: KHP27240

Functions of the left control lever and the right control lever.

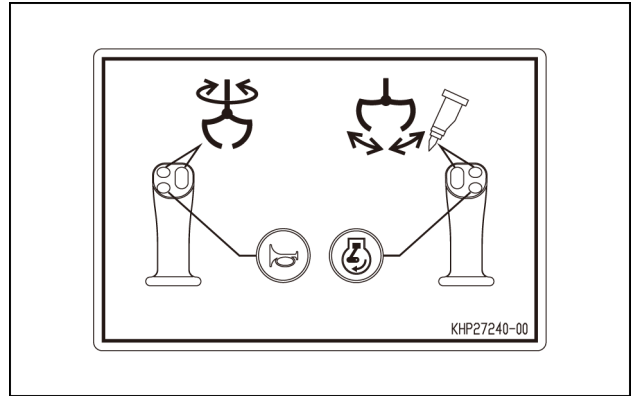

KHP27240 52

(41C) Functions of operation levers (optional)

Part number: KHP27250

Functions of the left control lever.

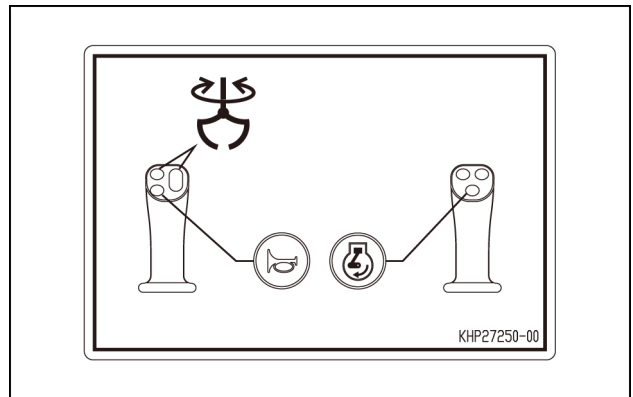

KHP27250 53